

0.80mm(0.032") Pitch
Pin Header Connector

0408011

Vertical, Through Hole

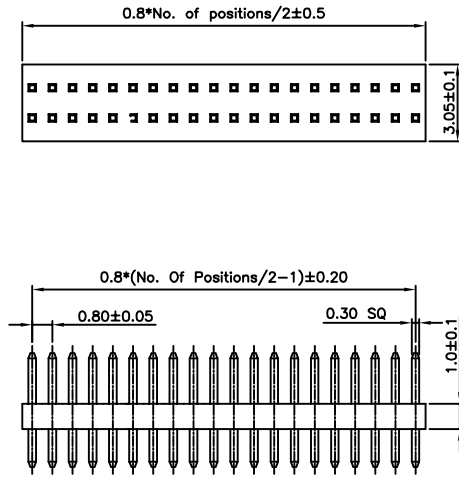

Specifications

Rating

Current Rating:0.8 Amp
Voltage Rating:100V AC/DC
Operating Temperature Range:-40°~+105°C

Electrical

Contact resistance:20m Ohm Max
Insulator resistance:500M ohm min.
Withstanding Voltage:500V AC/Minute

Material And Finish

Insulator:Nylon 6T UL94V-0 Color:Black
Contact:Brass
Plated:Gold Flash Over Nickel

No. of CKTS	Part No.	No. of CKTS	Part No.
		52	0408011-520101
04	0408011-040101	54	0408011-540101
06	0408011-060101	56	0408011-560101
08	0408011-080101	58	0408011-580101
10	0408011-100101	60	0408011-600101
12	0408011-120101	62	0408011-620101
14	0408011-140101	64	0408011-640101
16	0408011-160101	66	0408011-660101
18	0408011-180101	68	0408011-680101
20	0408011-200101	70	0408011-700101
22	0408011-220101	72	0408011-720101
24	0408011-240101	74	0408011-740101
26	0408011-260101	76	0408011-760101
28	0408011-280101	78	0408011-780101
30	0408011-300101	80	0408011-800101
32	0408011-320101	82	0408011-820101
34	0408011-340101	84	0408011-840101
36	0408011-360101	86	0408011-860101
38	0408011-380101	88	0408011-880101
40	0408011-400101	90	0408011-900101
42	0408011-420101	92	0408011-920101
44	0408011-440101	94	0408011-940101
46	0408011-460101	96	0408011-960101
48	0408011-480101	98	0408011-980101
50	0408011-500101	100	0408011-1000101

0.80mm(0.032") Pitch
Pin Header Connector

0408013

Vertical, SMT

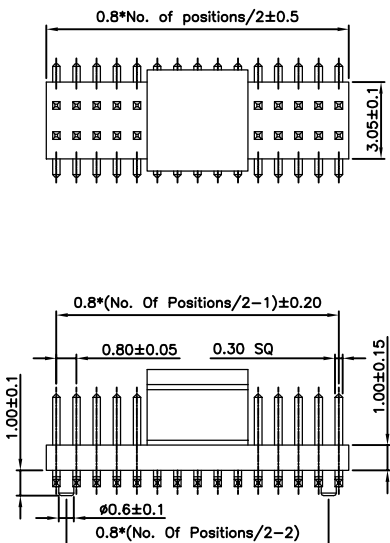

Specifications

Rating

Current Rating:0.8 Amp
Voltage Rating:100V AC/DC
Operating Temperature Range:-40°~+105°C

Electrical

Contact resistance:20m Ohm Max
Insulator resistance:500M ohm min.
Withstanding Voltage:500V AC/Minute

Material And Finish

Insulator:Nylon 6T UL94V-0 Color:Black
Contact:Brass
Plated:Gold Flash Over Nickel

No. of CKTS	Part No.	No. of CKTS	Part No.
		52	0408013-520104
04	0408013-040104	54	0408013-540104
06	0408013-060104	56	0408013-560104
08	0408013-080104	58	0408013-580104
10	0408013-100104	60	0408013-600104
12	0408013-120104	62	0408013-620104
14	0408013-140104	64	0408013-640104
16	0408013-160104	66	0408013-660104
18	0408013-180104	68	0408013-680104
20	0408013-200104	70	0408013-700104
22	0408013-220104	72	0408013-720104
24	0408013-240104	74	0408013-740104
26	0408013-260104	76	0408013-760104
28	0408013-280104	78	0408013-780104
30	0408013-300104	80	0408013-800104
32	0408013-320104	82	0408013-820104
34	0408013-340104	84	0408013-840104
36	0408013-360104	86	0408013-860104
38	0408013-380104	88	0408013-880104
40	0408013-400104	90	0408013-900104
42	0408013-420104	92	0408013-920104
44	0408013-440104	94	0408013-940104
46	0408013-460104	96	0408013-960104
48	0408013-480104	98	0408013-980104
50	0408013-500104	100	0408013-1000104

0.80mm(0.032") Pitch
Pin Header Connector

04080112

Vertical, Through Hole

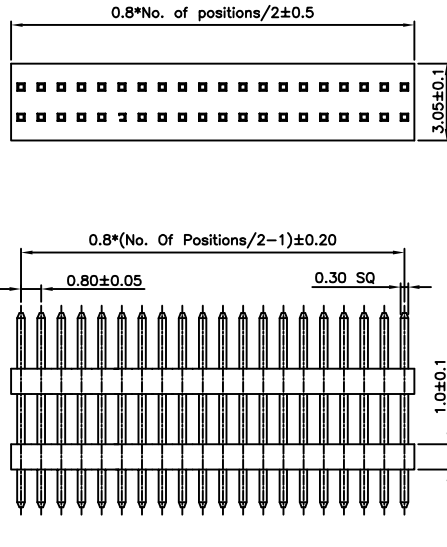

Specifications

Rating

Current Rating:0.8 Amp
Voltage Rating:100V AC/DC
Operating Temperature Range:-40~+105°C

Electrical

Contact resistance:20m Ohm Max
Insulator resistance:500M ohm min.
Withstanding Voltage:500V AC/Minute

Material And Finish

Insulator:Nylon 6T UL94V-0 Color:Black
Contact:Brass
Plated:Gold Flash Over Nickel

No.of CKTS	Part No.	No.of CKTS	Part No.
04	04080112-040101	52	04080112-520101
06	04080112-060101	54	04080112-540101
08	04080112-080101	56	04080112-560101
10	04080112-100101	58	04080112-580101
12	04080112-120101	60	04080112-600101
14	04080112-140101	62	04080112-620101
16	04080112-160101	64	04080112-640101
18	04080112-180101	66	04080112-660101
20	04080112-200101	68	04080112-680101
22	04080112-220101	70	04080112-700101
24	04080112-240101	72	04080112-720101
26	04080112-260101	74	04080112-740101
28	04080112-280101	76	04080112-760101
30	04080112-300101	78	04080112-780101
32	04080112-320101	80	04080112-800101
34	04080112-340101	82	04080112-820101
36	04080112-360101	84	04080112-840101
38	04080112-380101	86	04080112-860101
40	04080112-400101	88	04080112-880101
42	04080112-420101	90	04080112-900101
44	04080112-440101	92	04080112-920101
46	04080112-460101	94	04080112-940101
48	04080112-480101	96	04080112-960101
50	04080112-500101	98	04080112-980101
		100	04080112-1000101

0.80mm(0.032") Pitch
Pin Header Connector

04080132

Vertical, SMT

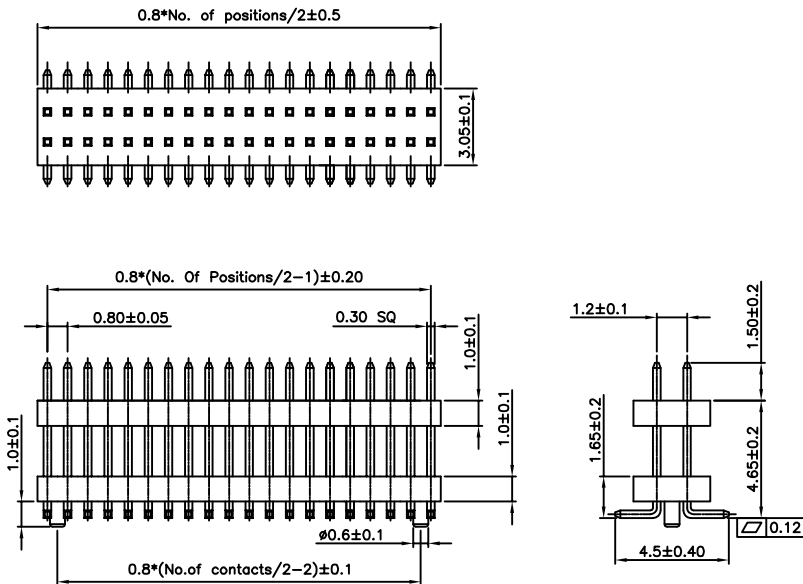

Specifications

Rating

Current Rating:0.8 Amp
Voltage Rating:100V AC/DC
Operating Temperature Range:-40~+105°C

Electrical

Contact resistance:20m Ohm Max
Insulator resistance:500M ohm min.
Withstanding Voltage:500V AC/Minute

Material And Finish

Insulator:Nylon 6T UL94V-0 Color:Black
Contact:Brass
Plated:Gold Flash Over Nickel

No.of CKTS	Part No.	No.of CKTS	Part No.
04	04080132-040104	52	04080132-520104
06	04080132-060104	54	04080132-540104
08	04080132-080104	56	04080132-560104
10	04080132-100104	58	04080132-580104
12	04080132-120104	60	04080132-600104
14	04080132-140104	62	04080132-620104
16	04080132-160104	64	04080132-640104
18	04080132-180104	66	04080132-660104
20	04080132-200104	68	04080132-680104
22	04080132-220104	70	04080132-700104
24	04080132-240104	72	04080132-720104
26	04080132-260104	74	04080132-740104
28	04080132-280104	76	04080132-760104
30	04080132-300104	78	04080132-780104
32	04080132-320104	80	04080132-800104
34	04080132-340104	82	04080132-820104
36	04080132-360104	84	04080132-840104
38	04080132-380104	86	04080132-860104
40	04080132-400104	88	04080132-880104
42	04080132-420104	90	04080132-900104
44	04080132-440104	92	04080132-920104
46	04080132-460104	94	04080132-940104
48	04080132-480104	96	04080132-960104
50	04080132-500104	98	04080132-980104
		100	04080132-1000104

0.80mm(0.032") Pitch
Pin Header Connector

0408021
Vertical, Through Hole

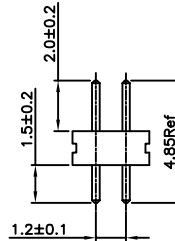
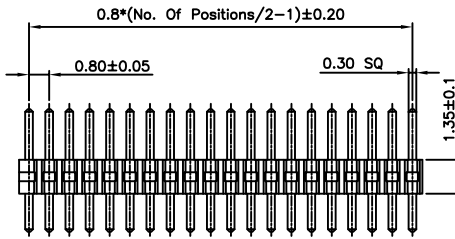
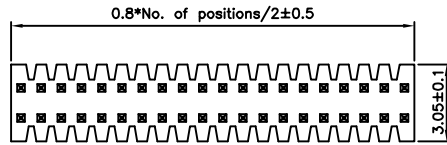

Specifications

Rating

Current Rating:0.8 Amp
Voltage Rating:100V AC/DC
Operating Temperature Range:-40°~+105°C

Electrical

Contact resistance:20m Ohm Max
Insulator resistance:500M ohm min.
Withstanding Voltage:500V AC/Minute

Material And Finish

Insulator:Nylon 6T UL94V-0 Color:Black
Contact:Brass
Plated:Gold Flash Over Nickel

No.of CKTS	Part No.	No.of CKTS	Part No.
		52	0408021-520101
04	0408021-040101	54	0408021-540101
06	0408021-060101	56	0408021-560101
08	0408021-080101	58	0408021-580101
10	0408021-100101	60	0408021-600101
12	0408021-120101	62	0408021-620101
14	0408021-140101	64	0408021-640101
16	0408021-160101	66	0408021-660101
18	0408021-180101	68	0408021-680101
20	0408021-200101	70	0408021-700101
22	0408021-220101	72	0408021-720101
24	0408021-240101	74	0408021-740101
26	0408021-260101	76	0408021-760101
28	0408021-280101	78	0408021-780101
30	0408021-300101	80	0408021-800101
32	0408021-320101	82	0408021-820101
34	0408021-340101	84	0408021-840101
36	0408021-360101	86	0408021-860101
38	0408021-380101	88	0408021-880101
40	0408021-400101	90	0408021-900101
42	0408021-420101	92	0408021-920101
44	0408021-440101	94	0408021-940101
46	0408021-460101	96	0408021-960101
48	0408021-480101	98	0408021-980101
50	0408021-500101	100	0408021-1000101

0.80mm(0.032") Pitch
Pin Header Connector

0408023
Vertical, SMT

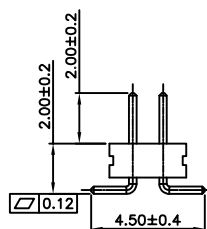
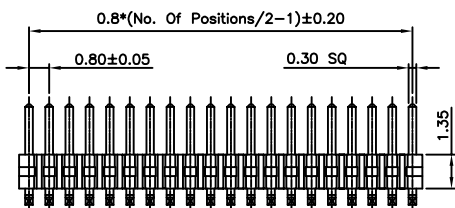
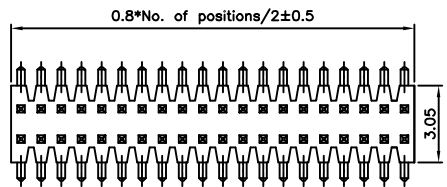

Specifications

Rating

Current Rating:0.8 Amp
Voltage Rating:100V AC/DC
Operating Temperature Range:-40°~+105°C

Electrical

Contact resistance:20m Ohm Max
Insulator resistance:500M ohm min.
Withstanding Voltage:500V AC/Minute

Material And Finish

Insulator:Nylon 6T UL94V-0 Color:Black
Contact:Brass
Plated:Gold Flash Over Nickel

No.of CKTS	Part No.	No.of CKTS	Part No.
		54	0408023-540101
04	0408023-040101	56	0408023-560101
06	0408023-060101	58	0408023-580101
08	0408023-080101	60	0408023-600101
10	0408023-100101	62	0408023-620101
12	0408023-120101	64	0408023-640101
14	0408023-140101	66	0408023-660101
16	0408023-160101	68	0408023-680101
18	0408023-180101	70	0408023-700101
20	0408023-200101	72	0408023-720101
22	0408023-220101	74	0408023-740101
24	0408023-240101	76	0408023-760101
26	0408023-260101	78	0408023-780101
28	0408023-280101	80	0408023-800101
30	0408023-300101	82	0408023-820101
32	0408023-320101	84	0408023-840101
34	0408023-340101	86	0408023-860101
36	0408023-360101	88	0408023-880101
38	0408023-380101	90	0408023-900101
40	0408023-400101	92	0408023-920101
42	0408023-420101	94	0408023-940101
44	0408023-440101	96	0408023-960101
46	0408023-460101	98	0408023-980101
48	0408023-480101	100	0408023-1000101
50	0408023-500101		
52	0408023-520101		

1.00mm(0.039") Pitch
Pin Header Connector

0410011

Vertical, Through Hole

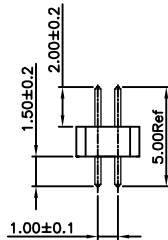
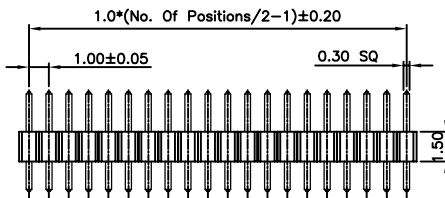
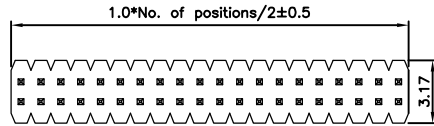

Specifications

Rating

Current Rating:0.8 Amp
Voltage Rating:100V AC/DC
Operating Temperature Range:-40°~+105°C

Electrical

Contact resistance:20m Ohm Max
Insulator resistance:500M ohm min.
Withstanding Voltage:500V AC/Minute

Material And Finish

Insulator:Nylon 6T UL94V-0 Color:Black
Contact:Brass
Plated:Gold Flash Over Nickel

No.of CKTS	Part No.	No.of CKTS	Part No.
04	0410011-040101	54	0410011-540101
06	0410011-060101	56	0410011-560101
08	0410011-080101	58	0410011-580101
10	0410011-100101	60	0410011-600101
12	0410011-120101	62	0410011-620101
14	0410011-140101	64	0410011-640101
16	0410011-160101	66	0410011-660101
18	0410011-180101	68	0410011-680101
20	0410011-200101	70	0410011-700101
22	0410011-220101	72	0410011-720101
24	0410011-240101	74	0410011-740101
26	0410011-260101	76	0410011-760101
28	0410011-280101	78	0410011-780101
30	0410011-300101	80	0410011-800101
32	0410011-320101	82	0410011-820101
34	0410011-340101	84	0410011-840101
36	0410011-360101	86	0410011-860101
38	0410011-380101	88	0410011-880101
40	0410011-400101	90	0410011-900101
42	0410011-420101	92	0410011-920101
44	0410011-440101	94	0410011-940101
46	0410011-460101	96	0410011-960101
48	0410011-480101	98	0410011-980101
50	0410011-500101	100	0410011-1000101
52	0410011-520101		

1.00mm(0.039") Pitch
Pin Header Connector

0410012

Vertical, Through Hole

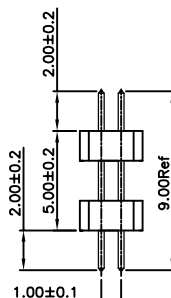
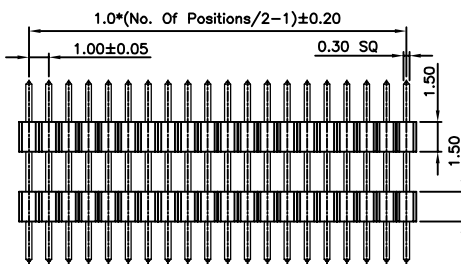
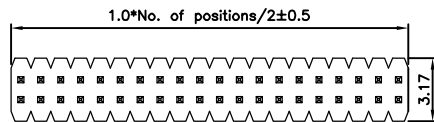

Specifications

Rating

Current Rating:0.8 Amp
Voltage Rating:100V AC/DC
Operating Temperature Range:-40°~+105°C

Electrical

Contact resistance:20m Ohm Max
Insulator resistance:500M ohm min.
Withstanding Voltage:500V AC/Minute

Material And Finish

Insulator:Nylon 6T UL94V-0 Color:Black
Contact:Brass
Plated:Gold Flash Over Nickel

No.of CKTS	Part No.	No.of CKTS	Part No.
04	0410012-040101	54	0410012-540101
06	0410012-060101	56	0410012-560101
08	0410012-080101	58	0410012-580101
10	0410012-100101	60	0410012-600101
12	0410012-120101	62	0410012-620101
14	0410012-140101	64	0410012-640101
16	0410012-160101	66	0410012-660101
18	0410012-180101	68	0410012-680101
20	0410012-200101	70	0410012-700101
22	0410012-220101	72	0410012-720101
24	0410012-240101	74	0410012-740101
26	0410012-260101	76	0410012-760101
28	0410012-280101	78	0410012-780101
30	0410012-300101	80	0410012-800101
32	0410012-320101	82	0410012-820101
34	0410012-340101	84	0410012-840101
36	0410012-360101	86	0410012-860101
38	0410012-380101	88	0410012-880101
40	0410012-400101	90	0410012-900101
42	0410012-420101	92	0410012-920101
44	0410012-440101	94	0410012-940101
46	0410012-460101	96	0410012-960101
48	0410012-480101	98	0410012-980101
50	0410012-500101	100	0410012-1000101
52	0410012-520101		

1.00mm(0.039") Pitch
Pin Header Connector

0410012
Right Angle, Through Hole

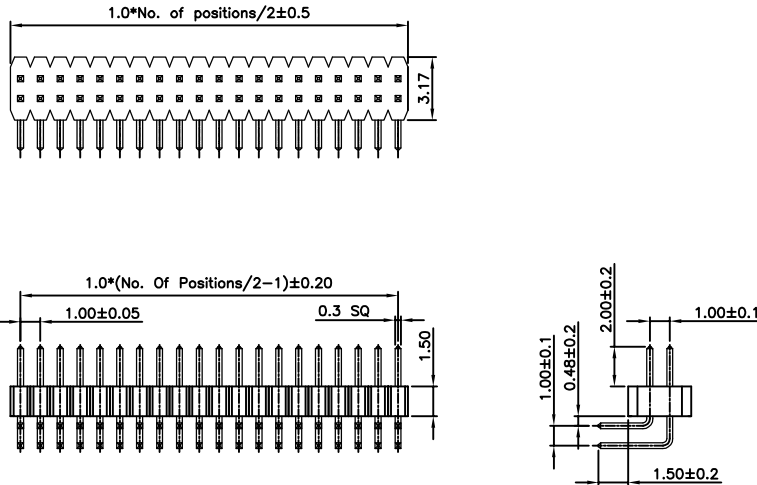

Specifications

Rating

Current Rating:0.8 Amp
Voltage Rating:100V AC/DC
Operating Temperature Range:-40°~+105°C

Electrical

Contact resistance:20m Ohm Max
Insulator resistance:500M ohm min.
Withstanding Voltage:500V AC/Minute

Material And Finish

Insulator:Nylon 6T UL94V-0 Color:Black
Contact:Brass
Plated:Gold Flash Over Nickel

No.of CKTS	Part No.	No.of CKTS	Part No.
04	0410012-040101	54	0410012-540101
06	0410012-060101	56	0410012-560101
08	0410012-080101	58	0410012-580101
10	0410012-100101	60	0410012-600101
12	0410012-120101	62	0410012-620101
14	0410012-140101	64	0410012-640101
16	0410012-160101	66	0410012-660101
18	0410012-180101	68	0410012-680101
20	0410012-200101	70	0410012-700101
22	0410012-220101	72	0410012-720101
24	0410012-240101	74	0410012-740101
26	0410012-260101	76	0410012-760101
28	0410012-280101	78	0410012-780101
30	0410012-300101	80	0410012-800101
32	0410012-320101	82	0410012-820101
34	0410012-340101	84	0410012-840101
36	0410012-360101	86	0410012-860101
38	0410012-380101	88	0410012-880101
40	0410012-400101	90	0410012-900101
42	0410012-420101	92	0410012-920101
44	0410012-440101	94	0410012-940101
46	0410012-460101	96	0410012-960101
48	0410012-480101	98	0410012-980101
50	0410012-500101	100	0410012-1000101
52	0410012-520101		

1.00mm(0.039") Pitch
Pin Header Connector

04100122
Right Angle, Through Hole

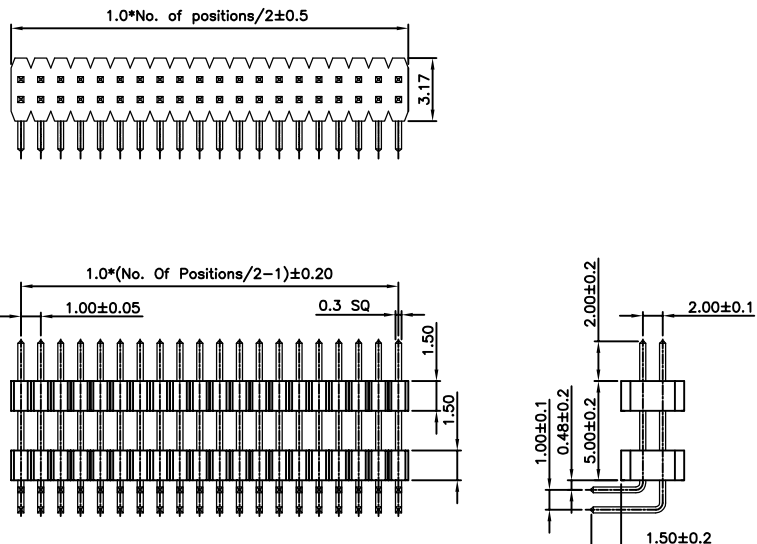

Specifications

Rating

Current Rating:0.8 Amp
Voltage Rating:100V AC/DC
Operating Temperature Range:-40°~+105°C

Electrical

Contact resistance:20m Ohm Max
Insulator resistance:500M ohm min.
Withstanding Voltage:500V AC/Minute

Material And Finish

Insulator:Nylon 6T UL94V-0 Color:Black
Contact:Brass
Plated:Gold Flash Over Nickel

No.of CKTS	Part No.	No.of CKTS	Part No.
04	04100122-040101	54	04100122-540101
06	04100122-060101	56	04100122-560101
08	04100122-080101	58	04100122-580101
10	04100122-100101	60	04100122-600101
12	04100122-120101	62	04100122-620101
14	04100122-140101	64	04100122-640101
16	04100122-160101	66	04100122-660101
18	04100122-180101	68	04100122-680101
20	04100122-200101	70	04100122-700101
22	04100122-220101	72	04100122-720101
24	04100122-240101	74	04100122-740101
26	04100122-260101	76	04100122-760101
28	04100122-280101	78	04100122-780101
30	04100122-300101	80	04100122-800101
32	04100122-320101	82	04100122-820101
34	04100122-340101	84	04100122-840101
36	04100122-360101	86	04100122-860101
38	04100122-380101	88	04100122-880101
40	04100122-400101	90	04100122-900101
42	04100122-420101	92	04100122-920101
44	04100122-440101	94	04100122-940101
46	04100122-460101	96	04100122-960101
48	04100122-480101	98	04100122-980101
50	04100122-500101	100	04100122-1000101
52	04100122-520101		

1.00mm(0.039") Pitch
Pin Header Connector

0410013
Vertical, SMT

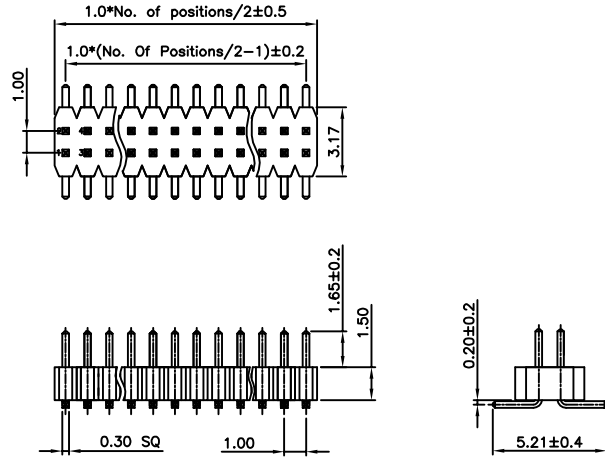

Specifications

Rating

Current Rating: 0.8 Amp
Voltage Rating: 100V AC/DC
Operating Temperature Range: $-40^{\circ} \sim +105^{\circ} \text{C}$

Electrical

Contact resistance: 20m Ohm Max
Insulator resistance: 500M ohm min.
Withstanding Voltage: 500V AC/Minute

Material And Finish

Insulator: Nylon 6T UL94V-0 Color: Black
Contact: Brass
Plated: Gold Flash Over Nickel

No. of CKTS	Part No.	No. of CKTS	Part No.
04	0410013-040101	54	0410013-540101
06	0410013-060101	56	0410013-560101
08	0410013-080101	58	0410013-580101
10	0410013-100101	60	0410013-600101
12	0410013-120101	62	0410013-620101
14	0410013-140101	64	0410013-640101
16	0410013-160101	66	0410013-660101
18	0410013-180101	68	0410013-680101
20	0410013-200101	70	0410013-700101
22	0410013-220101	72	0410013-720101
24	0410013-240101	74	0410013-740101
26	0410013-260101	76	0410013-760101
28	0410013-280101	78	0410013-780101
30	0410013-300101	80	0410013-800101
32	0410013-320101	82	0410013-820101
34	0410013-340101	84	0410013-840101
36	0410013-360101	86	0410013-860101
38	0410013-380101	88	0410013-880101
40	0410013-400101	90	0410013-900101
42	0410013-420101	92	0410013-920101
44	0410013-440101	94	0410013-940101
46	0410013-460101	96	0410013-960101
48	0410013-480101	98	0410013-980101
50	0410013-500101	100	0410013-1000101
52	0410013-520101		

1.00mm(0.039") Pitch
Pin Header Connector

04100132
Vertical, SMT

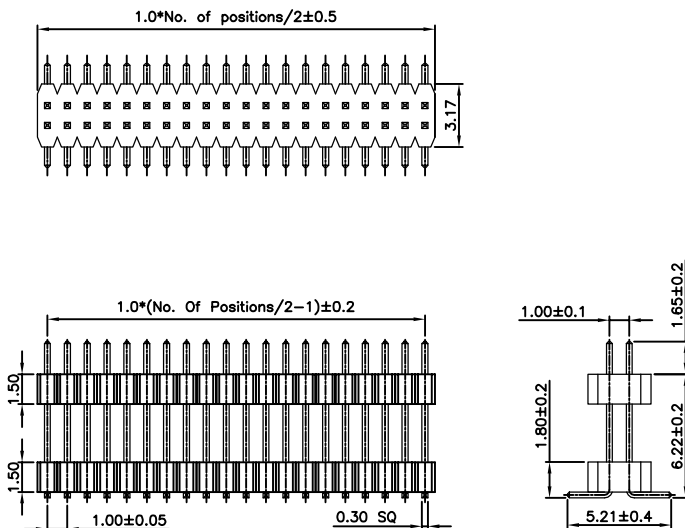

Specifications

Rating

Current Rating: 0.8 Amp
Voltage Rating: 100V AC/DC
Operating Temperature Range: $-40^{\circ} \sim +105^{\circ} \text{C}$

Electrical

Contact resistance: 20m Ohm Max
Insulator resistance: 500M ohm min.
Withstanding Voltage: 500V AC/Minute

Material And Finish

Insulator: Nylon 6T UL94V-0 Color: Black
Contact: Brass
Plated: Gold Flash Over Nickel

No. of CKTS	Part No.	No. of CKTS	Part No.
04	04100132-040101	54	04100132-540101
06	04100132-060101	56	04100132-560101
08	04100132-080101	58	04100132-580101
10	04100132-100101	60	04100132-600101
12	04100132-120101	62	04100132-620101
14	04100132-140101	64	04100132-640101
16	04100132-160101	66	04100132-660101
18	04100132-180101	68	04100132-680101
20	04100132-200101	70	04100132-700101
22	04100132-220101	72	04100132-720101
24	04100132-240101	74	04100132-740101
26	04100132-260101	76	04100132-760101
28	04100132-280101	78	04100132-780101
30	04100132-300101	80	04100132-800101
32	04100132-320101	82	04100132-820101
34	04100132-340101	84	04100132-840101
36	04100132-360101	86	04100132-860101
38	04100132-380101	88	04100132-880101
40	04100132-400101	90	04100132-900101
42	04100132-420101	92	04100132-920101
44	04100132-440101	94	04100132-940101
46	04100132-460101	96	04100132-960101
48	04100132-480101	98	04100132-980101
50	04100132-500101	100	04100132-1000101
52	04100132-520101		

1.00mm(0.039") Pitch
Pin Header Connector

0410031
Vertical, Through Hole

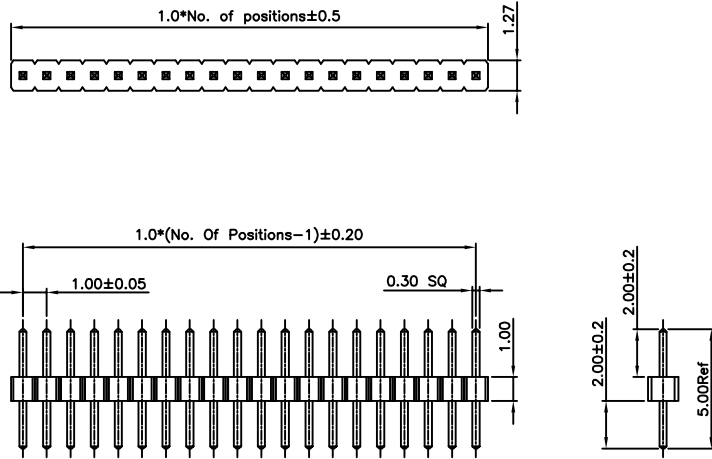

Specifications

Rating

Current Rating:0.8 Amp
Voltage Rating:100V AC/DC
Operating Temperature Range:-40~+105°C

Electrical

Contact resistance:20m Ohm Max
Insulator resistance:500M ohm min.
Withstanding Voltage:500V AC/Minute

Material And Finish

Insulator:Nylon 6T UL94V-0 Color:Black
Contact:Brass
Plated:Gold Flash Over Nickel

No.of CKTS	Part No.	No.of CKTS	Part No.
01	0410031-010101	26	0410031-260101
02	0410031-020101	27	0410031-270101
03	0410031-030101	28	0410031-280101
04	0410031-040101	29	0410031-290101
05	0410031-050101	30	0410031-300101
06	0410031-060101	31	0410031-310101
07	0410031-070101	32	0410031-320101
08	0410031-080101	33	0410031-330101
09	0410031-090101	34	0410031-340101
10	0410031-100101	35	0410031-350101
11	0410031-110101	36	0410031-360101
12	0410031-120101	37	0410031-370101
13	0410031-130101	38	0410031-380101
14	0410031-140101	39	0410031-390101
15	0410031-150101	40	0410031-400101
16	0410031-160101	41	0410031-410101
17	0410031-170101	42	0410031-420101
18	0410031-180101	43	0410031-430101
19	0410031-190101	44	0410031-440101
20	0410031-200101	45	0410031-450101
21	0410031-210101	46	0410031-460101
22	0410031-220101	47	0410031-470101
23	0410031-230101	48	0410031-480101
24	0410031-240101	49	0410031-490101
25	0410031-250101	50	0410031-500101

1.00mm(0.039") Pitch
Pin Header Connector

04100312
Vertical, Through Hole

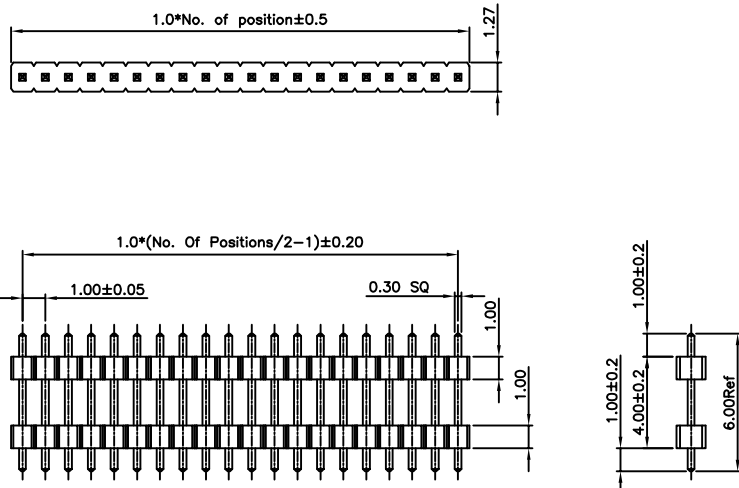

Specifications

Rating

Current Rating:0.8 Amp
Voltage Rating:100V AC/DC
Operating Temperature Range:-40~+105°C

Electrical

Contact resistance:20m Ohm Max
Insulator resistance:500M ohm min.
Withstanding Voltage:500V AC/Minute

Material And Finish

Insulator:Nylon 6T UL94V-0 Color:Black
Contact:Brass
Plated:Gold Flash Over Nickel

No.of CKTS	Part No.	No.of CKTS	Part No.
01	04100312-010101	26	04100312-260101
02	04100312-020101	27	04100312-270101
03	04100312-030101	28	04100312-280101
04	04100312-040101	29	04100312-290101
05	04100312-050101	30	04100312-300101
06	04100312-060101	31	04100312-310101
07	04100312-070101	32	04100312-320101
08	04100312-080101	33	04100312-330101
09	04100312-090101	34	04100312-340101
10	04100312-100101	35	04100312-350101
11	04100312-110101	36	04100312-360101
12	04100312-120101	37	04100312-370101
13	04100312-130101	38	04100312-380101
14	04100312-140101	39	04100312-390101
15	04100312-150101	40	04100312-400101
16	04100312-160101	41	04100312-410101
17	04100312-170101	42	04100312-420101
18	04100312-180101	43	04100312-430101
19	04100312-190101	44	04100312-440101
20	04100312-200101	45	04100312-450101
21	04100312-210101	46	04100312-460101
22	04100312-220101	47	04100312-470101
23	04100312-230101	48	04100312-480101
24	04100312-240101	49	04100312-490101
25	04100312-250101	50	04100312-500101

1.00mm(0.039") Pitch
Pin Header Connector

0410032
Right Angle, Through Hole

Specifications

Rating

Current Rating:0.8 Amp
Voltage Rating:100V AC/DC
Operating Temperature Range:-40~+105°C

Electrical

Contact resistance:20m Ohm Max
Insulator resistance:500M ohm min.
Withstanding Voltage:500V AC/Minute

Material And Finish

Insulator:Nylon 6T UL94V-0 Color:Black
Contact:Brass
Plated:Gold Flash Over Nickel

No.of CKTS	Part No.	No.of CKTS	Part No.
01	0410032-010101	26	0410032-260101
02	0410032-020101	27	0410032-270101
03	0410032-030101	28	0410032-280101
04	0410032-040101	29	0410032-290101
05	0410032-050101	30	0410032-300101
06	0410032-060101	31	0410032-310101
07	0410032-070101	32	0410032-320101
08	0410032-080101	33	0410032-330101
09	0410032-090101	34	0410032-340101
10	0410032-100101	35	0410032-350101
11	0410032-110101	36	0410032-360101
12	0410032-120101	37	0410032-370101
13	0410032-130101	38	0410032-380101
14	0410032-140101	39	0410032-390101
15	0410032-150101	40	0410032-400101
16	0410032-160101	41	0410032-410101
17	0410032-170101	42	0410032-420101
18	0410032-180101	43	0410032-430101
19	0410032-190101	44	0410032-440101
20	0410032-200101	45	0410032-450101
21	0410032-210101	46	0410032-460101
22	0410032-220101	47	0410032-470101
23	0410032-230101	48	0410032-480101
24	0410032-240101	49	0410032-490101
25	0410032-250101	50	0410032-500101

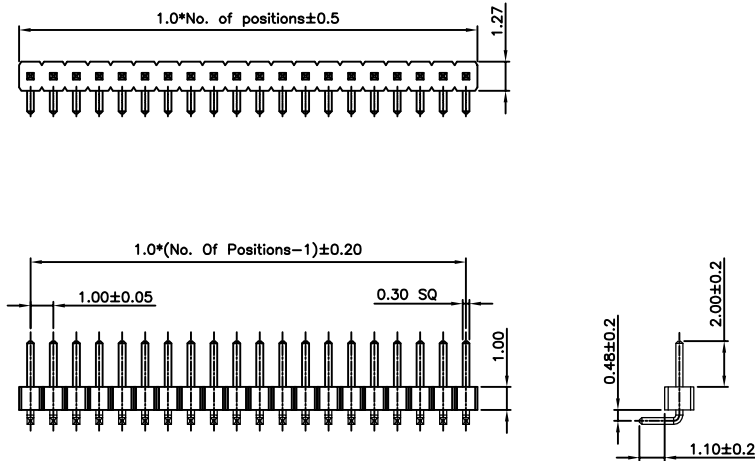

1.00mm(0.039") Pitch
Pin Header Connector

04100322
Right Angle, Through Hole

Specifications

Rating

Current Rating:0.8 Amp
Voltage Rating:100V AC/DC
Operating Temperature Range:-40~+105°C

Electrical

Contact resistance:20m Ohm Max
Insulator resistance:500M ohm min.
Withstanding Voltage:500V AC/Minute

Material And Finish

Insulator:Nylon 6T UL94V-0 Color:Black
Contact:Brass
Plated:Gold Flash Over Nickel

No.of CKTS	Part No.	No.of CKTS	Part No.
01	04100322-010101	26	04100322-260101
02	04100322-020101	27	04100322-270101
03	04100322-030101	28	04100322-280101
04	04100322-040101	29	04100322-290101
05	04100322-050101	30	04100322-300101
06	04100322-060101	31	04100322-310101
07	04100322-070101	32	04100322-320101
08	04100322-080101	33	04100322-330101
09	04100322-090101	34	04100322-340101
10	04100322-100101	35	04100322-350101
11	04100322-110101	36	04100322-360101
12	04100322-120101	37	04100322-370101
13	04100322-130101	38	04100322-380101
14	04100322-140101	39	04100322-390101
15	04100322-150101	40	04100322-400101
16	04100322-160101	41	04100322-410101
17	04100322-170101	42	04100322-420101
18	04100322-180101	43	04100322-430101
19	04100322-190101	44	04100322-440101
20	04100322-200101	45	04100322-450101
21	04100322-210101	46	04100322-460101
22	04100322-220101	47	04100322-470101
23	04100322-230101	48	04100322-480101
24	04100322-240101	49	04100322-490101
25	04100322-250101	50	04100322-500101

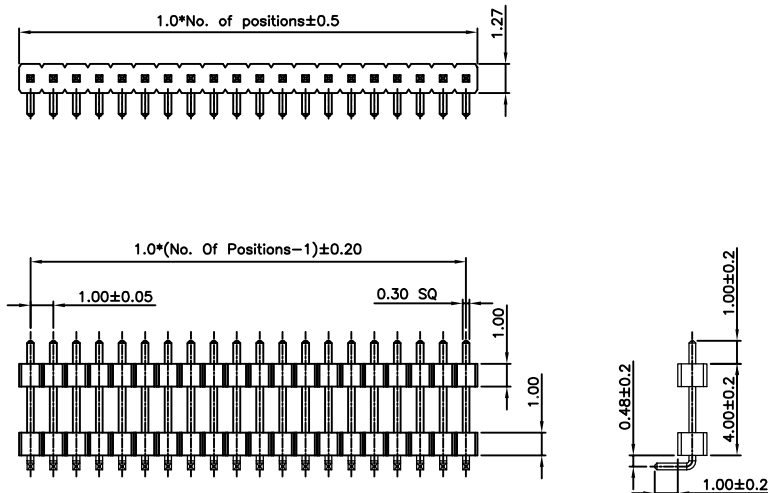

1.00mm(0.039") Pitch
Pin Header Connector

0410033
Vertical, SMT

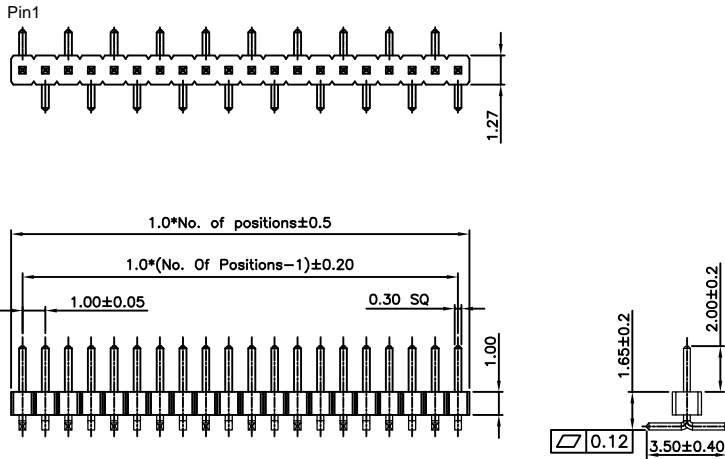

Specifications

Rating

Current Rating:0.8 Amp
Voltage Rating:100V AC/DC
Operating Temperature Range:-40~+105°C

Electrical

Contact resistance:20m Ohm Max
Insulator resistance:500M ohm min.
Withstanding Voltage:500V AC/Minute

Material And Finish

Insulator:Nylon 6T UL94V-0 Color:Black
Contact:Brass
Plated:Gold Flash Over Nickel

No.of CKTS	Part No.	No.of CKTS	Part No.
02	0410033-020101	26	0410033-260101
03	0410033-030101	27	0410033-270101
04	0410033-040101	28	0410033-280101
05	0410033-050101	29	0410033-290101
06	0410033-060101	30	0410033-300101
07	0410033-070101	31	0410033-310101
08	0410033-080101	32	0410033-320101
09	0410033-090101	33	0410033-330101
10	0410033-100101	34	0410033-340101
11	0410033-110101	35	0410033-350101
12	0410033-120101	36	0410033-360101
13	0410033-130101	37	0410033-370101
14	0410033-140101	38	0410033-380101
15	0410033-150101	39	0410033-390101
16	0410033-160101	40	0410033-400101
17	0410033-170101	41	0410033-410101
18	0410033-180101	42	0410033-420101
19	0410033-190101	43	0410033-430101
20	0410033-200101	44	0410033-440101
21	0410033-210101	45	0410033-450101
22	0410033-220101	46	0410033-460101
23	0410033-230101	47	0410033-470101
24	0410033-240101	48	0410033-480101
25	0410033-250101	49	0410033-490101
		50	0410033-500101

1.00mm(0.039") Pitch
Pin Header Connector

04100332
Vertical, SMT

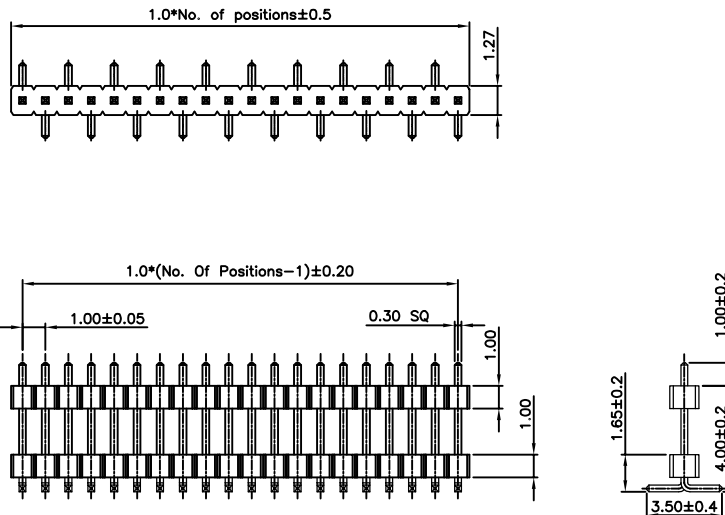

Specifications

Rating

Current Rating:0.8 Amp
Voltage Rating:100V AC/DC
Operating Temperature Range:-40~+105°C

Electrical

Contact resistance:20m Ohm Max
Insulator resistance:500M ohm min.
Withstanding Voltage:500V AC/Minute

Material And Finish

Insulator:Nylon 6T UL94V-0 Color:Black
Contact:Brass
Plated:Gold Flash Over Nickel

No.of CKTS	Part No.	No.of CKTS	Part No.
02	04100332-020101	26	04100332-260101
03	04100332-030101	27	04100332-270101
04	04100332-040101	28	04100332-280101
05	04100332-050101	29	04100332-290101
06	04100332-060101	30	04100332-300101
07	04100332-070101	31	04100332-310101
08	04100332-080101	32	04100332-320101
09	04100332-090101	33	04100332-330101
10	04100332-100101	34	04100332-340101
11	04100332-110101	35	04100332-350101
12	04100332-120101	36	04100332-360101
13	04100332-130101	37	04100332-370101
14	04100332-140101	38	04100332-380101
15	04100332-150101	39	04100332-390101
16	04100332-160101	40	04100332-400101
17	04100332-170101	41	04100332-410101
18	04100332-180101	42	04100332-420101
19	04100332-190101	43	04100332-430101
20	04100332-200101	44	04100332-440101
21	04100332-210101	45	04100332-450101
22	04100332-220101	46	04100332-460101
23	04100332-230101	47	04100332-470101
24	04100332-240101	48	04100332-480101
25	04100332-250101	49	04100332-490101
		50	04100332-500101

1.00mm(0.039") Pitch
Pin Header Connector

0410021

Vertical, Through Hole

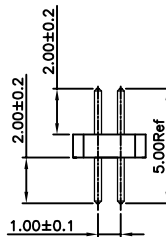
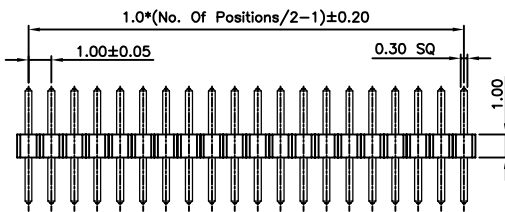
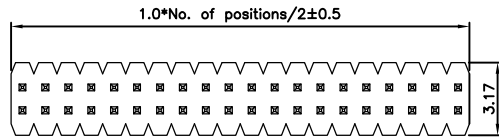

Specifications

Rating

Current Rating:0.8 Amp

Voltage Rating:100V AC/DC

Operating Temperature Range:-40~+105°C

Electrical

Contact resistance:20m Ohm Max

Insulator resistance:500M ohm min.

Withstanding Voltage:500V AC/Minute

Material And Finish

Insulator:Nylon 6T UL94V-0 Color:Black

Contact:Brass

Plated:Gold Flash Over Nickel

No.of CKTS	Part No.	No.of CKTS	Part No.
04	0410021-040101	54	0410021-540101
06	0410021-060101	56	0410021-560101
08	0410021-080101	58	0410021-580101
10	0410021-100101	60	0410021-600101
12	0410021-120101	62	0410021-620101
14	0410021-140101	64	0410021-640101
16	0410021-160101	66	0410021-660101
18	0410021-180101	68	0410021-680101
20	0410021-200101	70	0410021-700101
22	0410021-220101	72	0410021-720101
24	0410021-240101	74	0410021-740101
26	0410021-260101	76	0410021-760101
28	0410021-280101	78	0410021-780101
30	0410021-300101	80	0410021-800101
32	0410021-320101	82	0410021-820101
34	0410021-340101	84	0410021-840101
36	0410021-360101	86	0410021-860101
38	0410021-380101	88	0410021-880101
40	0410021-400101	90	0410021-900101
42	0410021-420101	92	0410021-920101
44	0410021-440101	94	0410021-940101
46	0410021-460101	96	0410021-960101
48	0410021-480101	98	0410021-980101
50	0410021-500101	100	0410021-1000101
52	0410021-520101		

1.00mm(0.039") Pitch
Pin Header Connector

04100212

Vertical, Through Hole

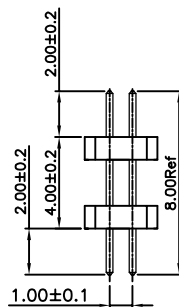
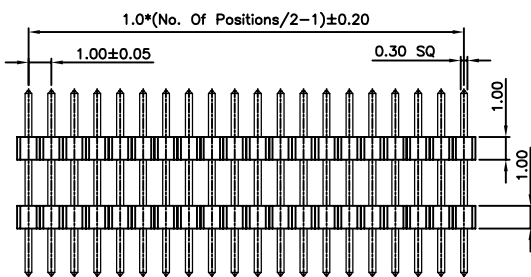
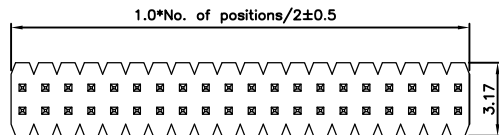

Specifications

Rating

Current Rating:0.8 Amp

Voltage Rating:100V AC/DC

Operating Temperature Range:-40~+105°C

Electrical

Contact resistance:20m Ohm Max

Insulator resistance:500M ohm min.

Withstanding Voltage:500V AC/Minute

Material And Finish

Insulator:Nylon 6T UL94V-0 Color:Black

Contact:Brass

Plated:Gold Flash Over Nickel

No.of CKTS	Part No.	No.of CKTS	Part No.
04	04100212-040101	54	04100212-540101
06	04100212-060101	56	04100212-560101
08	04100212-080101	58	04100212-580101
10	04100212-100101	60	04100212-600101
12	04100212-120101	62	04100212-620101
14	04100212-140101	64	04100212-640101
16	04100212-160101	66	04100212-660101
18	04100212-180101	68	04100212-680101
20	04100212-200101	70	04100212-700101
22	04100212-220101	72	04100212-720101
24	04100212-240101	74	04100212-740101
26	04100212-260101	76	04100212-760101
28	04100212-280101	78	04100212-780101
30	04100212-300101	80	04100212-800101
32	04100212-320101	82	04100212-820101
34	04100212-340101	84	04100212-840101
36	04100212-360101	86	04100212-860101
38	04100212-380101	88	04100212-880101
40	04100212-400101	90	04100212-900101
42	04100212-420101	92	04100212-920101
44	04100212-440101	94	04100212-940101
46	04100212-460101	96	04100212-960101
48	04100212-480101	98	04100212-980101
50	04100212-500101	100	04100212-1000101
52	04100212-520101		

1.00mm(0.039") Pitch
Pin Header Connector

0410022
Right Angle, Through Hole

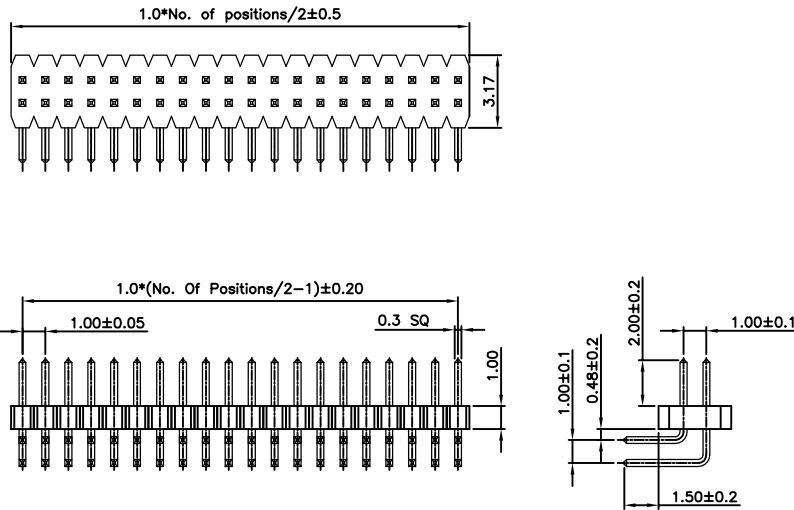

Specifications

Rating

Current Rating:0.8 Amp
Voltage Rating:100V AC/DC
Operating Temperature Range:-40~+105°C

Electrical

Contact resistance:20m Ohm Max
Insulator resistance:500M ohm min.
Withstanding Voltage:500V AC/Minute

Material And Finish

Insulator:Nylon 6T UL94V-0 Color:Black
Contact:Brass
Plated:Gold Flash Over Nickel

No.of CKTS	Part No.	No.of CKTS	Part No.
04	0410022-040101	54	0410022-540101
06	0410022-060101	56	0410022-560101
08	0410022-080101	58	0410022-580101
10	0410022-100101	60	0410022-600101
12	0410022-120101	62	0410022-620101
14	0410022-140101	64	0410022-640101
16	0410022-160101	66	0410022-660101
18	0410022-180101	68	0410022-680101
20	0410022-200101	70	0410022-700101
22	0410022-220101	72	0410022-720101
24	0410022-240101	74	0410022-740101
26	0410022-260101	76	0410022-760101
28	0410022-280101	78	0410022-780101
30	0410022-300101	80	0410022-800101
32	0410022-320101	82	0410022-820101
34	0410022-340101	84	0410022-840101
36	0410022-360101	86	0410022-860101
38	0410022-380101	88	0410022-880101
40	0410022-400101	90	0410022-900101
42	0410022-420101	92	0410022-920101
44	0410022-440101	94	0410022-940101
46	0410022-460101	96	0410022-960101
48	0410022-480101	98	0410022-980101
50	0410022-500101	100	0410022-1000101
52	0410022-520101		

1.00mm(0.039") Pitch
Pin Header Connector

04100222
Right Angle, Through Hole

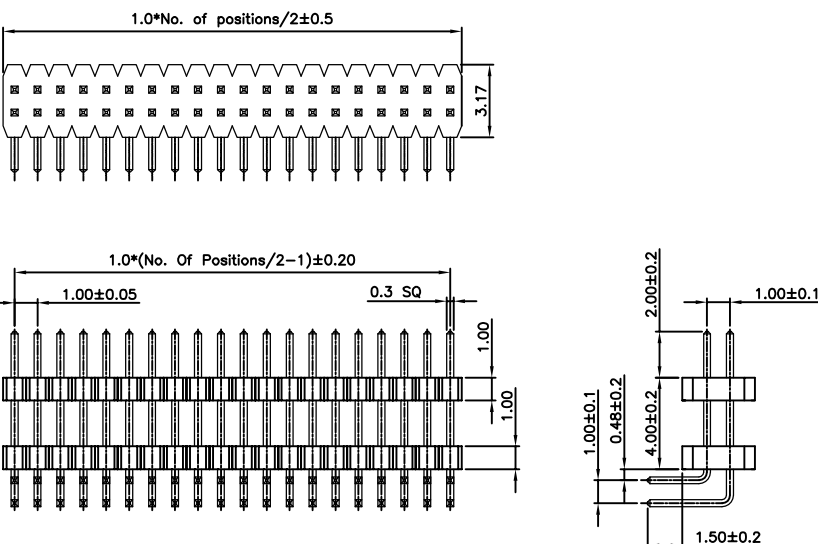

Specifications

Rating

Current Rating:0.8 Amp
Voltage Rating:100V AC/DC
Operating Temperature Range:-40~+105°C

Electrical

Contact resistance:20m Ohm Max
Insulator resistance:500M ohm min.
Withstanding Voltage:500V AC/Minute

Material And Finish

Insulator:Nylon 6T UL94V-0 Color:Black
Contact:Brass
Plated:Gold Flash Over Nickel

No.of CKTS	Part No.	No.of CKTS	Part No.
04	04100222-040101	54	04100222-540101
06	04100222-060101	56	04100222-560101
08	04100222-080101	58	04100222-580101
10	04100222-100101	60	04100222-600101
12	04100222-120101	62	04100222-620101
14	04100222-140101	64	04100222-640101
16	04100222-160101	66	04100222-660101
18	04100222-180101	68	04100222-680101
20	04100222-200101	70	04100222-700101
22	04100222-220101	72	04100222-720101
24	04100222-240101	74	04100222-740101
26	04100222-260101	76	04100222-760101
28	04100222-280101	78	04100222-780101
30	04100222-300101	80	04100222-800101
32	04100222-320101	82	04100222-820101
34	04100222-340101	84	04100222-840101
36	04100222-360101	86	04100222-860101
38	04100222-380101	88	04100222-880101
40	04100222-400101	90	04100222-900101
42	04100222-420101	92	04100222-920101
44	04100222-440101	94	04100222-940101
46	04100222-460101	96	04100222-960101
48	04100222-480101	98	04100222-980101
50	04100222-500101	100	04100222-1000101
52	04100222-520101		

1.00mm(0.039") Pitch
Pin Header Connector

0410023
Vertical, SMT

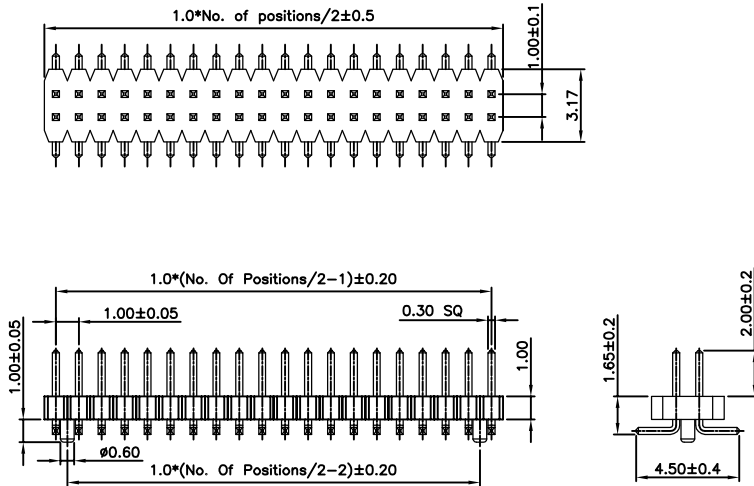

Specifications

Rating

Current Rating:0.8 Amp
Voltage Rating:100V AC/DC
Operating Temperature Range:-40~+105°C

Electrical

Contact resistance:20m Ohm Max
Insulator resistance:500M ohm min.
Withstanding Voltage:500V AC/Minute

Material And Finish

Insulator:Nylon 6T UL94V-0 Color:Black
Contact:Brass
Plated:Gold Flash Over Nickel

No.of CKTS	Part No.	No.of CKTS	Part No.
04	0410023-040101	54	0410023-540101
06	0410023-060101	56	0410023-560101
08	0410023-080101	58	0410023-580101
10	0410023-100101	60	0410023-600101
12	0410023-120101	62	0410023-620101
14	0410023-140101	64	0410023-640101
16	0410023-160101	66	0410023-660101
18	0410023-180101	68	0410023-680101
20	0410023-200101	70	0410023-700101
22	0410023-220101	72	0410023-720101
24	0410023-240101	74	0410023-740101
26	0410023-260101	76	0410023-760101
28	0410023-280101	78	0410023-780101
30	0410023-300101	80	0410023-800101
32	0410023-320101	82	0410023-820101
34	0410023-340101	84	0410023-840101
36	0410023-360101	86	0410023-860101
38	0410023-380101	88	0410023-880101
40	0410023-400101	90	0410023-900101
42	0410023-420101	92	0410023-920101
44	0410023-440101	94	0410023-940101
46	0410023-460101	96	0410023-960101
48	0410023-480101	98	0410023-980101
50	0410023-500101	100	0410023-1000101
52	0410023-520101		

1.00mm(0.039") Pitch
Pin Header Connector

04100232
Vertical, SMT

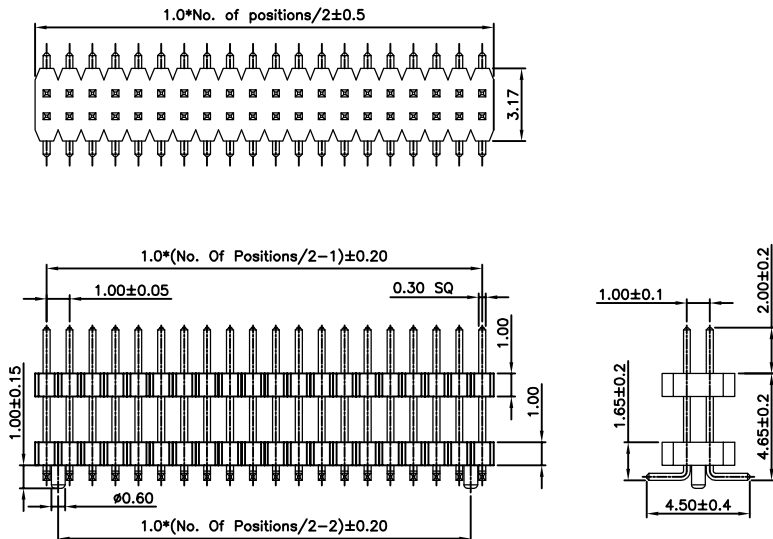

Specifications

Rating

Current Rating:0.8 Amp
Voltage Rating:100V AC/DC
Operating Temperature Range:-40~+105°C

Electrical

Contact resistance:20m Ohm Max
Insulator resistance:500M ohm min.
Withstanding Voltage:500V AC/Minute

Material And Finish

Insulator:Nylon 6T UL94V-0 Color:Black
Contact:Brass
Plated:Gold Flash Over Nickel

No.of CKTS	Part No.	No.of CKTS	Part No.
04	04100232-040101	54	04100232-540101
06	04100232-060101	56	04100232-560101
08	04100232-080101	58	04100232-580101
10	04100232-100101	60	04100232-600101
12	04100232-120101	62	04100232-620101
14	04100232-140101	64	04100232-640101
16	04100232-160101	66	04100232-660101
18	04100232-180101	68	04100232-680101
20	04100232-200101	70	04100232-700101
22	04100232-220101	72	04100232-720101
24	04100232-240101	74	04100232-740101
26	04100232-260101	76	04100232-760101
28	04100232-280101	78	04100232-780101
30	04100232-300101	80	04100232-800101
32	04100232-320101	82	04100232-820101
34	04100232-340101	84	04100232-840101
36	04100232-360101	86	04100232-860101
38	04100232-380101	88	04100232-880101
40	04100232-400101	90	04100232-900101
42	04100232-420101	92	04100232-920101
44	04100232-440101	94	04100232-940101
46	04100232-460101	96	04100232-960101
48	04100232-480101	98	04100232-980101
50	04100232-500101	100	04100232-1000101
52	04100232-520101		

1.00mm(0.039") Pitch
Pin Header Connector

0410043
Vertical, SMT

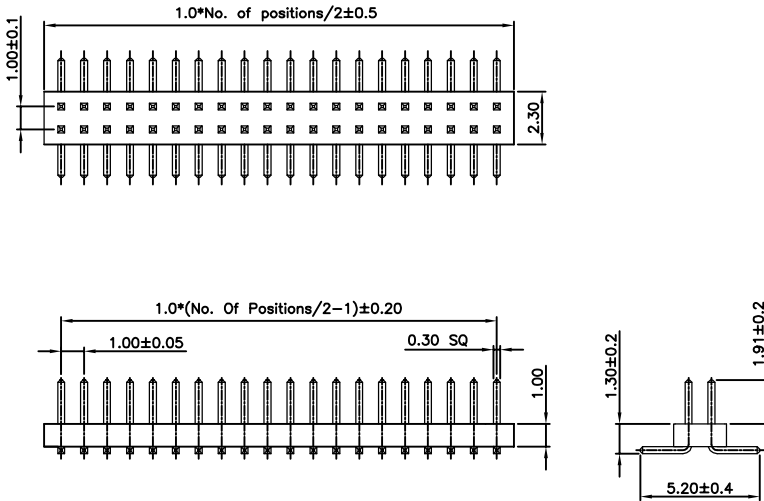

Specifications

Rating

Current Rating:0.8 Amp
Voltage Rating:100V AC/DC
Operating Temperature Range:-40°~+105°C

Electrical

Contact resistance:20m Ohm Max
Insulator resistance:500M ohm min.
Withstanding Voltage:500V AC/Minute

Material And Finish

Insulator:Nylon 6T UL94V-0 Color:Black
Contact:Brass
Plated:Gold Flash Over Nickel

No.of CKTS	Part No.	No.of CKTS	Part No.
04	0410043-040101	54	0410043-540101
06	0410043-060101	56	0410043-560101
08	0410043-080101	58	0410043-580101
10	0410043-100101	60	0410043-600101
12	0410043-120101	62	0410043-620101
14	0410043-140101	64	0410043-640101
16	0410043-160101	66	0410043-660101
18	0410043-180101	68	0410043-680101
20	0410043-200101	70	0410043-700101
22	0410043-220101	72	0410043-720101
24	0410043-240101	74	0410043-740101
26	0410043-260101	76	0410043-760101
28	0410043-280101	78	0410043-780101
30	0410043-300101	80	0410043-800101
32	0410043-320101	82	0410043-820101
34	0410043-340101	84	0410043-840101
36	0410043-360101	86	0410043-860101
38	0410043-380101	88	0410043-880101
40	0410043-400101	90	0410043-900101
42	0410043-420101	92	0410043-920101
44	0410043-440101	94	0410043-940101
46	0410043-460101	96	0410043-960101
48	0410043-480101	98	0410043-980101
50	0410043-500101	100	0410043-1000101
52	0410043-520101		

1.00mm(0.039") Pitch
Pin Header Connector

0410053
Vertical, SMT

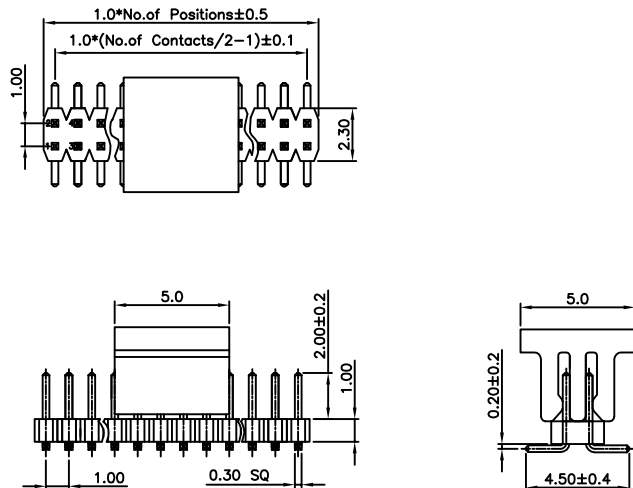

Specifications

Rating

Current Rating:0.8 Amp
Voltage Rating:100V AC/DC
Operating Temperature Range:-40°~+105°C

Electrical

Contact resistance:20m Ohm Max
Insulator resistance:500M ohm min.
Withstanding Voltage:500V AC/Minute

Material And Finish

Insulator:Nylon 6T UL94V-0 Color:Black
Contact:Brass
Plated:Gold Flash Over Nickel

No.of CKTS	Part No.	No.of CKTS	Part No.
04	0410053-040104	52	0410053-520104
06	0410053-060104	54	0410053-540104
08	0410053-080104	56	0410053-560104
10	0410053-100104	58	0410053-580104
12	0410053-120104	60	0410053-600104
14	0410053-140104	62	0410053-620104
16	0410053-160104	64	0410053-640104
18	0410053-180104	66	0410053-660104
20	0410053-200104	68	0410053-680104
22	0410053-220104	70	0410053-700104
24	0410053-240104	72	0410053-720104
26	0410053-260104	74	0410053-740104
28	0410053-280104	76	0410053-760104
30	0410053-300104	78	0410053-780104
32	0410053-320104	80	0410053-800104
34	0410053-340104	82	0410053-820104
36	0410053-360104	84	0410053-840104
38	0410053-380104	86	0410053-860104
40	0410053-400104	88	0410053-880104
42	0410053-420104	90	0410053-900104
44	0410053-440104	92	0410053-920104
46	0410053-460104	94	0410053-940104
48	0410053-480104	96	0410053-960104
50	0410053-500104	98	0410053-980104
		100	0410053-1000104

1.27mm(0.05") Pitch
Pin Header Connector

0413011
Vertical, Through Hole

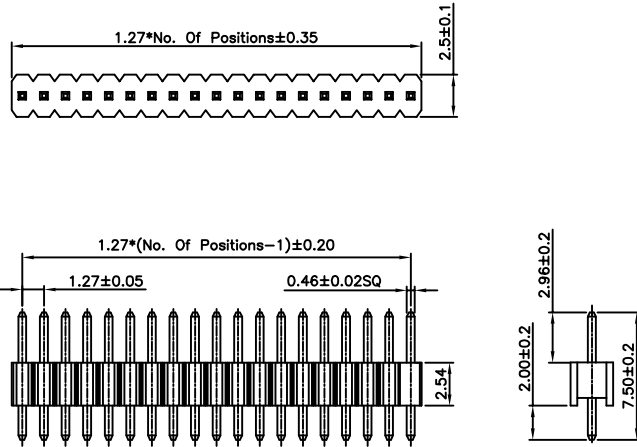

Specifications

Rating

Current Rating:1.0 Amp
Voltage Rating:100V AC/DC
Operating Temperature Range:-40°~+105°C

Electrical

Contact resistance:20m Ohm Max
Insulator resistance:500M ohm min.
Withstanding Voltage:500V AC/Minute

Material And Finish

Insulator:Nylon 6T UL94V-0 Color:Black
Contact:Brass
Plated:Gold Flash Over Nickel

No.of CKTS	Part No.	No.of CKTS	Part No.
01	0413011-010100	26	0413011-260100
02	0413011-020100	27	0413011-270100
03	0413011-030100	28	0413011-280100
04	0413011-040100	29	0413011-290100
05	0413011-050100	30	0413011-300100
06	0413011-060100	31	0413011-310100
07	0413011-070100	32	0413011-320100
08	0413011-080100	33	0413011-330100
09	0413011-090100	34	0413011-340100
10	0413011-100100	35	0413011-350100
11	0413011-110100	36	0413011-360100
12	0413011-120100	37	0413011-370100
13	0413011-130100	38	0413011-380100
14	0413011-140100	39	0413011-390100
15	0413011-150100	40	0413011-400100
16	0413011-160100	41	0413011-410100
17	0413011-170100	42	0413011-420100
18	0413011-180100	43	0413011-430100
19	0413011-190100	44	0413011-440100
20	0413011-200100	45	0413011-450100
21	0413011-210100	46	0413011-460100
22	0413011-220100	47	0413011-470100
23	0413011-230100	48	0413011-480100
24	0413011-240100	49	0413011-490100
25	0413011-250100	50	0413011-500100

1.27mm(0.05") Pitch
Pin Header Connector

0413012
Vertical, Through Hole

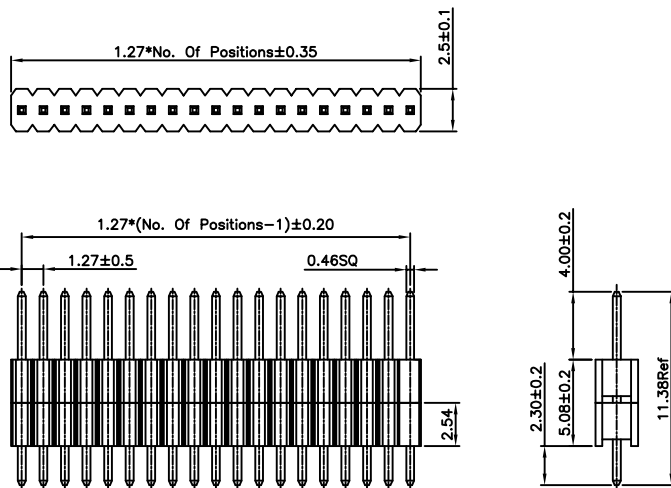

Specifications

Rating

Current Rating:1.0 Amp
Voltage Rating:100V AC/DC
Operating Temperature Range:-40°~+105°C

Electrical

Contact resistance:20m Ohm Max
Insulator resistance:500M ohm min.
Withstanding Voltage:500V AC/Minute

Material And Finish

Insulator:Nylon 6T UL94V-0 Color:Black
Contact:Brass
Plated:Gold Flash Over Nickel

No.of CKTS	Part No.	No.of CKTS	Part No.
01	0413012-010101	26	0413012-260101
02	0413012-020101	27	0413012-270101
03	0413012-030101	28	0413012-280101
04	0413012-040101	29	0413012-290101
05	0413012-050101	30	0413012-300101
06	0413012-060101	31	0413012-310101
07	0413012-070101	32	0413012-320101
08	0413012-080101	33	0413012-330101
09	0413012-090101	34	0413012-340101
10	0413012-100101	35	0413012-350101
11	0413012-110101	36	0413012-360101
12	0413012-120101	37	0413012-370101
13	0413012-130101	38	0413012-380101
14	0413012-140101	39	0413012-390101
15	0413012-150101	40	0413012-400101
16	0413012-160101	41	0413012-410101
17	0413012-170101	42	0413012-420101
18	0413012-180101	43	0413012-430101
19	0413012-190101	44	0413012-440101
20	0413012-200101	45	0413012-450101
21	0413012-210101	46	0413012-460101
22	0413012-220101	47	0413012-470101
23	0413012-230101	48	0413012-480101
24	0413012-240101	49	0413012-490101
25	0413012-250101	50	0413012-500101

1.27mm(0.05") Pitch
Pin Header Connector

0413012
Right Angle, Through Hole

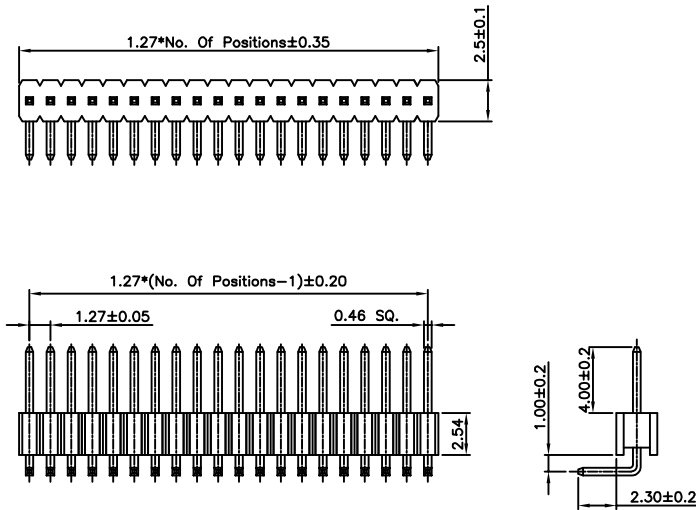

Specifications

Rating

Current Rating:1.0 Amp
Voltage Rating:100V AC/DC
Operating Temperature Range:-40°~+105°C

Electrical

Contact resistance:20m Ohm Max
Insulator resistance:500M ohm min.
Withstanding Voltage:500V AC/Minute

Material And Finish

Insulator:Nylon 6T UL94V-0 Color:Black
Contact:Brass
Plated:Gold Flash Over Nickel

No.of CKTS	Part No.	No.of CKTS	Part No.
01	0413012-010100	26	0413012-260100
02	0413012-020100	27	0413012-270100
03	0413012-030100	28	0413012-280100
04	0413012-040100	29	0413012-290100
05	0413012-050100	30	0413012-300100
06	0413012-060100	31	0413012-310100
07	0413012-070100	32	0413012-320100
08	0413012-080100	33	0413012-330100
09	0413012-090100	34	0413012-340100
10	0413012-100100	35	0413012-350100
11	0413012-110100	36	0413012-360100
12	0413012-120100	37	0413012-370100
13	0413012-130100	38	0413012-380100
14	0413012-140100	39	0413012-390100
15	0413012-150100	40	0413012-400100
16	0413012-160100	41	0413012-410100
17	0413012-170100	42	0413012-420100
18	0413012-180100	43	0413012-430100
19	0413012-190100	44	0413012-440100
20	0413012-200100	45	0413012-450100
21	0413012-210100	46	0413012-460100
22	0413012-220100	47	0413012-470100
23	0413012-230100	48	0413012-480100
24	0413012-240100	49	0413012-490100
25	0413012-250100	50	0413012-500100

1.27mm(0.05") Pitch
Pin Header Connector

04130122
Right Angle, Through Hole

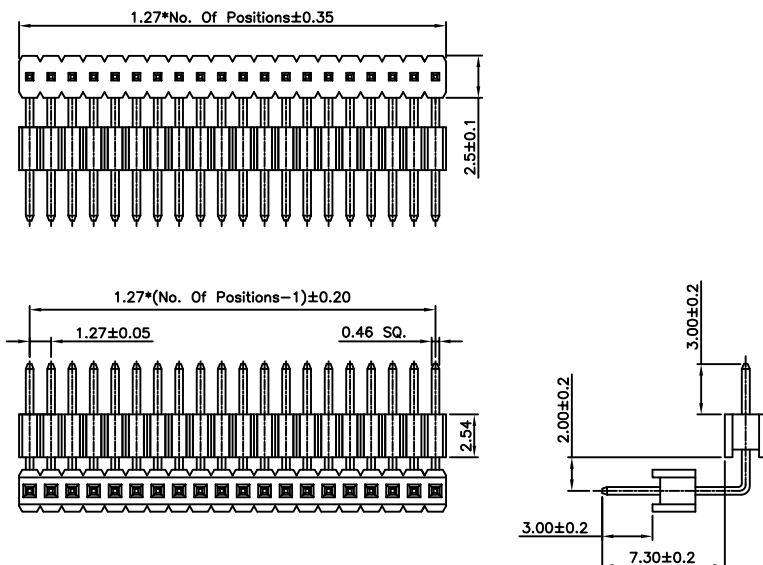

Specifications

Rating

Current Rating:1.0 Amp
Voltage Rating:100V AC/DC
Operating Temperature Range:-40°~+105°C

Electrical

Contact resistance:20m Ohm Max
Insulator resistance:500M ohm min.
Withstanding Voltage:500V AC/Minute

Material And Finish

Insulator:Nylon 6T UL94V-0 Color:Black
Contact:Brass
Plated:Gold Flash Over Nickel

No.of CKTS	Part No.	No.of CKTS	Part No.
01	04130122-010100	26	04130122-260100
02	04130122-020100	27	04130122-270100
03	04130122-030100	28	04130122-280100
04	04130122-040100	29	04130122-290100
05	04130122-050100	30	04130122-300100
06	04130122-060100	31	04130122-310100
07	04130122-070100	32	04130122-320100
08	04130122-080100	33	04130122-330100
09	04130122-090100	34	04130122-340100
10	04130122-100100	35	04130122-350100
11	04130122-110100	36	04130122-360100
12	04130122-120100	37	04130122-370100
13	04130122-130100	38	04130122-380100
14	04130122-140100	39	04130122-390100
15	04130122-150100	40	04130122-400100
16	04130122-160100	41	04130122-410100
17	04130122-170100	42	04130122-420100
18	04130122-180100	43	04130122-430100
19	04130122-190100	44	04130122-440100
20	04130122-200100	45	04130122-450100
21	04130122-210100	46	04130122-460100
22	04130122-220100	47	04130122-470100
23	04130122-230100	48	04130122-480100
24	04130122-240100	49	04130122-490100
25	04130122-250100	50	04130122-500100

1.27mm(0.05") Pitch
Pin Header Connector

0413013
Vertical, SMT

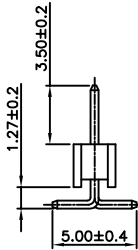
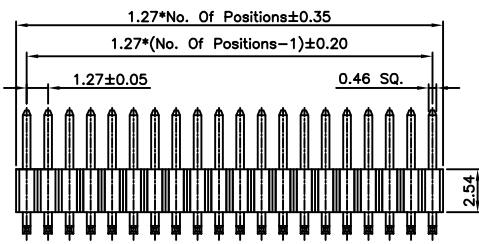
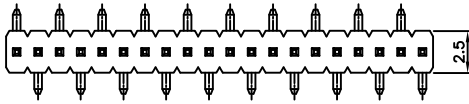

Specifications

Rating

Current Rating:1.0 Amp
Voltage Rating:100V AC/DC
Operating Temperature Range:-40°~+105°C

Electrical

Contact resistance:20m Ohm Max
Insulator resistance:500M ohm min.
Withstanding Voltage:500V AC/Minute

Material And Finish

Insulator:Nylon 6T UL94V-0 Color:Black
Contact:Brass
Plated:Gold Flash Over Nickel

No.of CKTS	Part No.	No.of CKTS	Part No.
02	0413013-020101	26	0413013-260101
03	0413013-030101	27	0413013-270101
04	0413013-040101	28	0413013-280101
05	0413013-050101	29	0413013-290101
06	0413013-060101	30	0413013-300101
07	0413013-070101	31	0413013-310101
08	0413013-080101	32	0413013-320101
09	0413013-090101	33	0413013-330101
10	0413013-100101	34	0413013-340101
11	0413013-110101	35	0413013-350101
12	0413013-120101	36	0413013-360101
13	0413013-130101	37	0413013-370101
14	0413013-140101	38	0413013-380101
15	0413013-150101	39	0413013-390101
16	0413013-160101	40	0413013-400101
17	0413013-170101	41	0413013-410101
18	0413013-180101	42	0413013-420101
19	0413013-190101	43	0413013-430101
20	0413013-200101	44	0413013-440101
21	0413013-210101	45	0413013-450101
22	0413013-220101	46	0413013-460101
23	0413013-230101	47	0413013-470101
24	0413013-240101	48	0413013-480101
25	0413013-250101	49	0413013-490101
		50	0413013-500101

1.27mm(0.05") Pitch
Pin Header Connector

04130132
Vertical, SMT

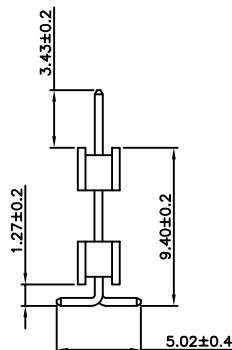
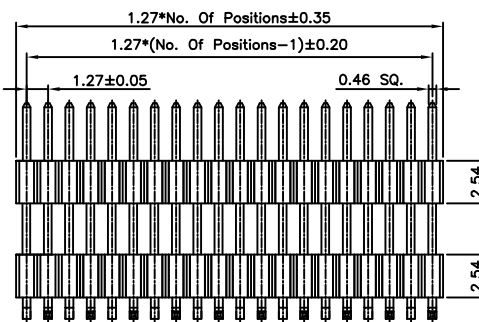
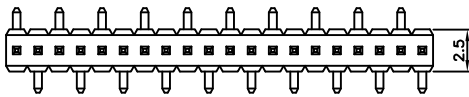

Specifications

Rating

Current Rating:1.0 Amp
Voltage Rating:100V AC/DC
Operating Temperature Range:-40°~+105°C

Electrical

Contact resistance:20m Ohm Max
Insulator resistance:500M ohm min.
Withstanding Voltage:500V AC/Minute

Material And Finish

Insulator:Nylon 6T UL94V-0 Color:Black
Contact:Brass
Plated:Gold Flash Over Nickel

No.of CKTS	Part No.	No.of CKTS	Part No.
02	04130132-020101	26	04130132-260101
03	04130132-030101	27	04130132-270101
04	04130132-040101	28	04130132-280101
05	04130132-050101	29	04130132-290101
06	04130132-060101	30	04130132-300101
07	04130132-070101	31	04130132-310101
08	04130132-080101	32	04130132-320101
09	04130132-090101	33	04130132-330101
10	04130132-100101	34	04130132-340101
11	04130132-110101	35	04130132-350101
12	04130132-120101	36	04130132-360101
13	04130132-130101	37	04130132-370101
14	04130132-140101	38	04130132-380101
15	04130132-150101	39	04130132-390101
16	04130132-160101	40	04130132-400101
17	04130132-170101	41	04130132-410101
18	04130132-180101	42	04130132-420101
19	04130132-190101	43	04130132-430101
20	04130132-200101	44	04130132-440101
21	04130132-210101	45	04130132-450101
22	04130132-220101	46	04130132-460101
23	04130132-230101	47	04130132-470101
24	04130132-240101	48	04130132-480101
25	04130132-250101	49	04130132-490101
		50	04130132-500101

1.27mm(0.05") Pitch
Pin Header Connector

0413021
Vertical, Through Hole

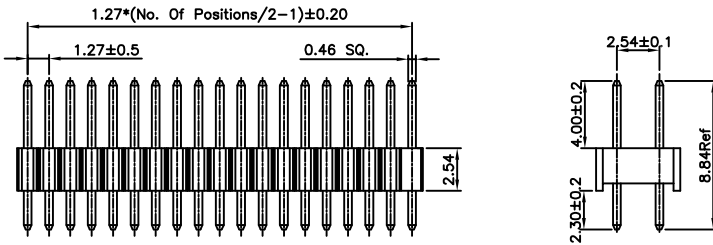
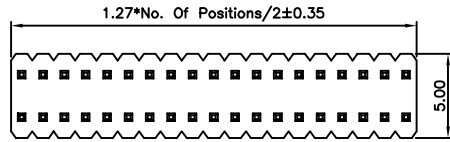

Specifications

Rating

Current Rating:1.0 Amp
Voltage Rating:100V AC/DC
Operating Temperature Range:-40~+105°C

Electrical

Contact resistance:20m Ohm Max
Insulator resistance:500M ohm min.
Withstanding Voltage:500V AC/Minute

Material And Finish

Insulator:Nylon 6T UL94V-0 Color:Black
Contact:Brass
Plated:Gold Flash Over Nickel

No.of CKTS	Part No.	No.of CKTS	Part No.
04	0413021-040100	54	0413021-540100
06	0413021-060100	56	0413021-560100
08	0413021-080100	58	0413021-580100
10	0413021-100100	60	0413021-600100
12	0413021-120100	62	0413021-620100
14	0413021-140100	64	0413021-640100
16	0413021-160100	66	0413021-660100
18	0413021-180100	68	0413021-680100
20	0413021-200100	70	0413021-700100
22	0413021-220100	72	0413021-720100
24	0413021-240100	74	0413021-740100
26	0413021-260100	76	0413021-760100
28	0413021-280100	78	0413021-780100
30	0413021-300100	80	0413021-800100
32	0413021-320100	82	0413021-820100
34	0413021-340100	84	0413021-840100
36	0413021-360100	86	0413021-860100
38	0413021-380100	88	0413021-880100
40	0413021-400100	90	0413021-900100
42	0413021-420100	92	0413021-920100
44	0413021-440100	94	0413021-940100
46	0413021-460100	96	0413021-960100
48	0413021-480100	98	0413021-980100
50	0413021-500100	100	0413021-1000100
52	0413021-520100		

1.27mm(0.05") Pitch
Pin Header Connector

04130212
Vertical, Through Hole

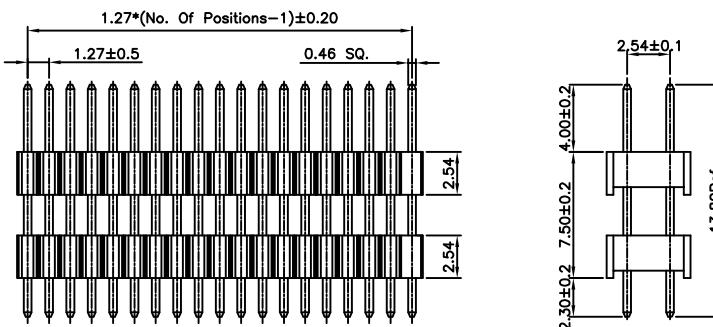
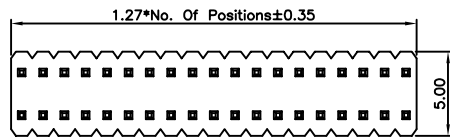

Specifications

Rating

Current Rating:1.0 Amp
Voltage Rating:100V AC/DC
Operating Temperature Range:-40~+105°C

Electrical

Contact resistance:20m Ohm Max
Insulator resistance:500M ohm min.
Withstanding Voltage:500V AC/Minute

Material And Finish

Insulator:Nylon 6T UL94V-0 Color:Black
Contact:Brass
Plated:Gold Flash Over Nickel

No.of CKTS	Part No.	No.of CKTS	Part No.
04	04130212-040100	54	04130212-540100
06	04130212-060100	56	04130212-560100
08	04130212-080100	58	04130212-580100
10	04130212-100100	60	04130212-600100
12	04130212-120100	62	04130212-620100
14	04130212-140100	64	04130212-640100
16	04130212-160100	66	04130212-660100
18	04130212-180100	68	04130212-680100
20	04130212-200100	70	04130212-700100
22	04130212-220100	72	04130212-720100
24	04130212-240100	74	04130212-740100
26	04130212-260100	76	04130212-760100
28	04130212-280100	78	04130212-780100
30	04130212-300100	80	04130212-800100
32	04130212-320100	82	04130212-820100
34	04130212-340100	84	04130212-840100
36	04130212-360100	86	04130212-860100
38	04130212-380100	88	04130212-880100
40	04130212-400100	90	04130212-900100
42	04130212-420100	92	04130212-920100
44	04130212-440100	94	04130212-940100
46	04130212-460100	96	04130212-960100
48	04130212-480100	98	04130212-980100
50	04130212-500100	100	04130212-1000100
52	04130212-520100		

1.27mm(0.05") Pitch
Pin Header Connector

0413022
Right Angle, Through Hole

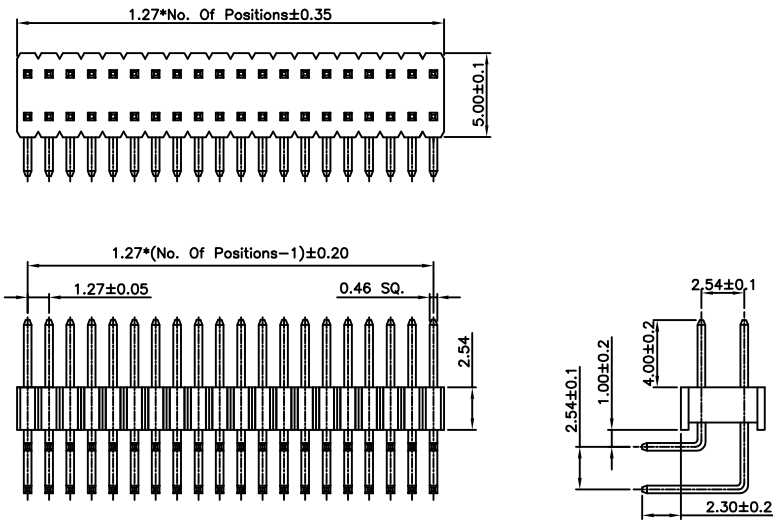

Specifications

Rating

Current Rating:1.0 Amp
Voltage Rating:100V AC/DC
Operating Temperature Range:-40°~+105°C

Electrical

Contact resistance:20m Ohm Max
Insulator resistance:500M ohm min.
Withstanding Voltage:500V AC/Minute

Material And Finish

Insulator:Nylon 6T UL94V-0 Color:Black
Contact:Brass
Plated:Gold Flash Over Nickel

No.of CKTS	Part No.	No.of CKTS	Part No.
04	0413022-040100	54	0413022-540100
06	0413022-060100	56	0413022-560100
08	0413022-080100	58	0413022-580100
10	0413022-100100	60	0413022-600100
12	0413022-120100	62	0413022-620100
14	0413022-140100	64	0413022-640100
16	0413022-160100	66	0413022-660100
18	0413022-180100	68	0413022-680100
20	0413022-200100	70	0413022-700100
22	0413022-220100	72	0413022-720100
24	0413022-240100	74	0413022-740100
26	0413022-260100	76	0413022-760100
28	0413022-280100	78	0413022-780100
30	0413022-300100	80	0413022-800100
32	0413022-320100	82	0413022-820100
34	0413022-340100	84	0413022-840100
36	0413022-360100	86	0413022-860100
38	0413022-380100	88	0413022-880100
40	0413022-400100	90	0413022-900100
42	0413022-420100	92	0413022-920100
44	0413022-440100	94	0413022-940100
46	0413022-460100	96	0413022-960100
48	0413022-480100	98	0413022-980100
50	0413022-500100	100	0413022-1000100
52	0413022-520100		

1.27mm(0.05") Pitch
Pin Header Connector

0413023
Vertical, SMT

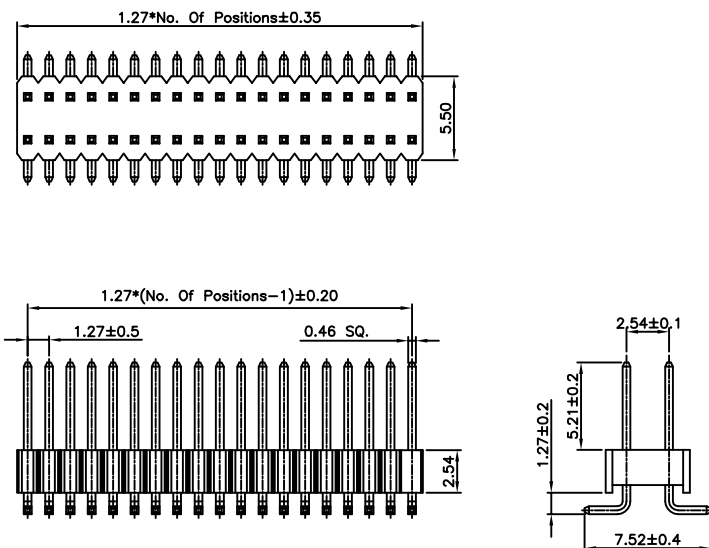

Specifications

Rating

Current Rating:1.0 Amp
Voltage Rating:100V AC/DC
Operating Temperature Range:-40°~+105°C

Electrical

Contact resistance:20m Ohm Max
Insulator resistance:500M ohm min.
Withstanding Voltage:500V AC/Minute

Material And Finish

Insulator:Nylon 6T UL94V-0 Color:Black
Contact:Brass
Plated:Gold Flash Over Nickel

No.of CKTS	Part No.	No.of CKTS	Part No.
04	0413023-040101	54	0413023-540101
06	0413023-060101	56	0413023-560101
08	0413023-080101	58	0413023-580101
10	0413023-100101	60	0413023-600101
12	0413023-120101	62	0413023-620101
14	0413023-140101	64	0413023-640101
16	0413023-160101	66	0413023-660101
18	0413023-180101	68	0413023-680101
20	0413023-200101	70	0413023-700101
22	0413023-220101	72	0413023-720101
24	0413023-240101	74	0413023-740101
26	0413023-260101	76	0413023-760101
28	0413023-280101	78	0413023-780101
30	0413023-300101	80	0413023-800101
32	0413023-320101	82	0413023-820101
34	0413023-340101	84	0413023-840101
36	0413023-360101	86	0413023-860101
38	0413023-380101	88	0413023-880101
40	0413023-400101	90	0413023-900101
42	0413023-420101	92	0413023-920101
44	0413023-440101	94	0413023-940101
46	0413023-460101	96	0413023-960101
48	0413023-480101	98	0413023-980101
50	0413023-500101	100	0413023-1000101
52	0413023-520101		

1.27mm(0.05") Pitch
Pin Header Connector

04130232
Vertical, SMT

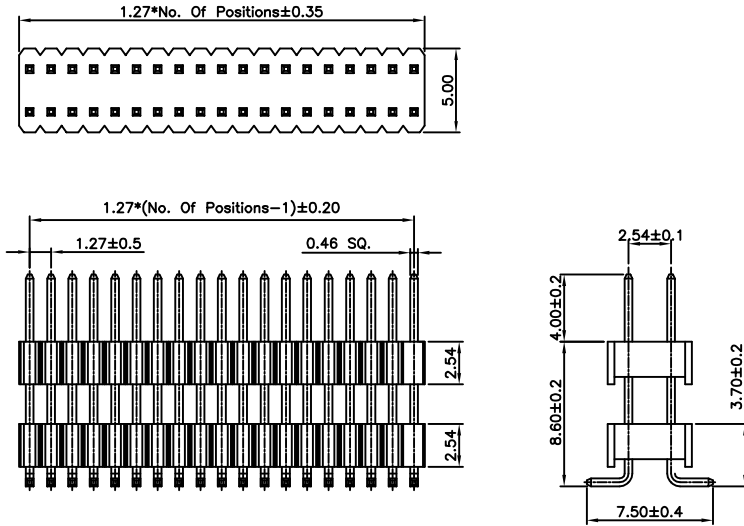

Specifications

Rating

Current Rating:1.0 Amp
Voltage Rating:100V AC/DC
Operating Temperature Range:-40~+105°C

Electrical

Contact resistance:20m Ohm Max
Insulator resistance:500M ohm min.
Withstanding Voltage:500V AC/Minute

Material And Finish

Insulator:Nylon 6T UL94V-0 Color:Black
Contact:Brass
Plated:Gold Flash Over Nickel

No.of CKTS	Part No.	No.of CKTS	Part No.
04	04130232-040101	54	04130232-540101
06	04130232-060101	56	04130232-560101
08	04130232-080101	58	04130232-580101
10	04130232-100101	60	04130232-600101
12	04130232-120101	62	04130232-620101
14	04130232-140101	64	04130232-640101
16	04130232-160101	66	04130232-660101
18	04130232-180101	68	04130232-680101
20	04130232-200101	70	04130232-700101
22	04130232-220101	72	04130232-720101
24	04130232-240101	74	04130232-740101
26	04130232-260101	76	04130232-760101
28	04130232-280101	78	04130232-780101
30	04130232-300101	80	04130232-800101
32	04130232-320101	82	04130232-820101
34	04130232-340101	84	04130232-840101
36	04130232-360101	86	04130232-860101
38	04130232-380101	88	04130232-880101
40	04130232-400101	90	04130232-900101
42	04130232-420101	92	04130232-920101
44	04130232-440101	94	04130232-940101
46	04130232-460101	96	04130232-960101
48	04130232-480101	98	04130232-980101
50	04130232-500101	100	04130232-1000101
52	04130232-520101		

1.27mm(0.05") Pitch
Pin Header Connector

0413031
Vertical, Through Hole

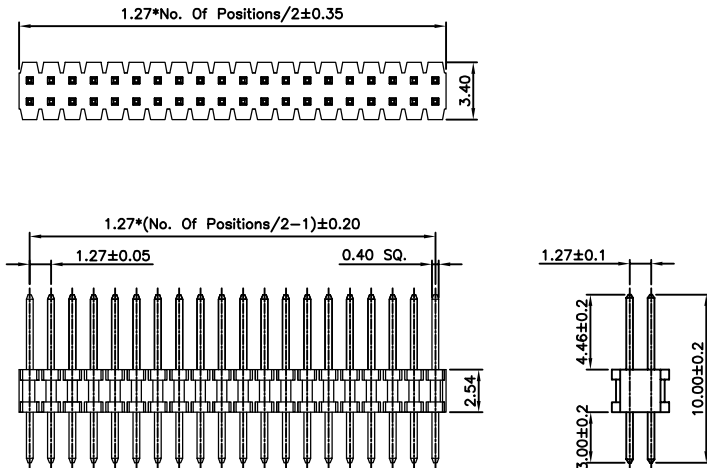

Specifications

Rating

Current Rating:1.0 Amp
Voltage Rating:100V AC/DC
Operating Temperature Range:-40~+105°C

Electrical

Contact resistance:20m Ohm Max
Insulator resistance:500M ohm min.
Withstanding Voltage:500V AC/Minute

Material And Finish

Insulator:Nylon 6T UL94V-0 Color:Black
Contact:Brass
Plated:Gold Flash Over Nickel

No.of CKTS	Part No.	No.of CKTS	Part No.
04	0413031-040101	54	0413031-540101
06	0413031-060101	56	0413031-560101
08	0413031-080101	58	0413031-580101
10	0413031-100101	60	0413031-600101
12	0413031-120101	62	0413031-620101
14	0413031-140101	64	0413031-640101
16	0413031-160101	66	0413031-660101
18	0413031-180101	68	0413031-680101
20	0413031-200101	70	0413031-700101
22	0413031-220101	72	0413031-720101
24	0413031-240101	74	0413031-740101
26	0413031-260101	76	0413031-760101
28	0413031-280101	78	0413031-780101
30	0413031-300101	80	0413031-800101
32	0413031-320101	82	0413031-820101
34	0413031-340101	84	0413031-840101
36	0413031-360101	86	0413031-860101
38	0413031-380101	88	0413031-880101
40	0413031-400101	90	0413031-900101
42	0413031-420101	92	0413031-920101
44	0413031-440101	94	0413031-940101
46	0413031-460101	96	0413031-960101
48	0413031-480101	98	0413031-980101
50	0413031-500101	100	0413031-1000101
52	0413031-520101		

1.27mm(0.05") Pitch
Pin Header Connector

04130312
Vertical, Through Hole

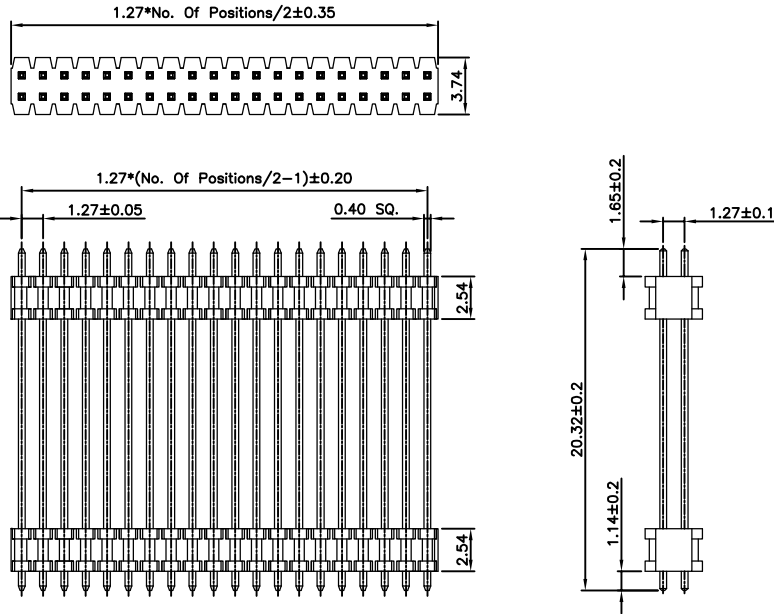

Specifications

Rating

Current Rating:1.0 Amp
Voltage Rating:100V AC/DC
Operating Temperature Range:-40°~+105°C

Electrical

Contact resistance:20m Ohm Max
Insulator resistance:500M ohm min.
Withstanding Voltage:500V AC/Minute

Material And Finish

Insulator:Nylon 6T UL94V-0 Color:Black
Contact:Brass
Plated:Gold Flash Over Nickel

No.of CKTS	Part No.	No.of CKTS	Part No.
04	04130312-040101	54	04130312-540101
06	04130312-060101	56	04130312-560101
08	04130312-080101	58	04130312-580101
10	04130312-100101	60	04130312-600101
12	04130312-120101	62	04130312-620101
14	04130312-140101	64	04130312-640101
16	04130312-160101	66	04130312-660101
18	04130312-180101	68	04130312-680101
20	04130312-200101	70	04130312-700101
22	04130312-220101	72	04130312-720101
24	04130312-240101	74	04130312-740101
26	04130312-260101	76	04130312-760101
28	04130312-280101	78	04130312-780101
30	04130312-300101	80	04130312-800101
32	04130312-320101	82	04130312-820101
34	04130312-340101	84	04130312-840101
36	04130312-360101	86	04130312-860101
38	04130312-380101	88	04130312-880101
40	04130312-400101	90	04130312-900101
42	04130312-420101	92	04130312-920101
44	04130312-440101	94	04130312-940101
46	04130312-460101	96	04130312-960101
48	04130312-480101	98	04130312-980101
50	04130312-500101	100	04130312-1000101
52	04130312-520101		

1.27mm(0.05") Pitch
Pin Header Connector

0413032
Right Angle, Through Hole

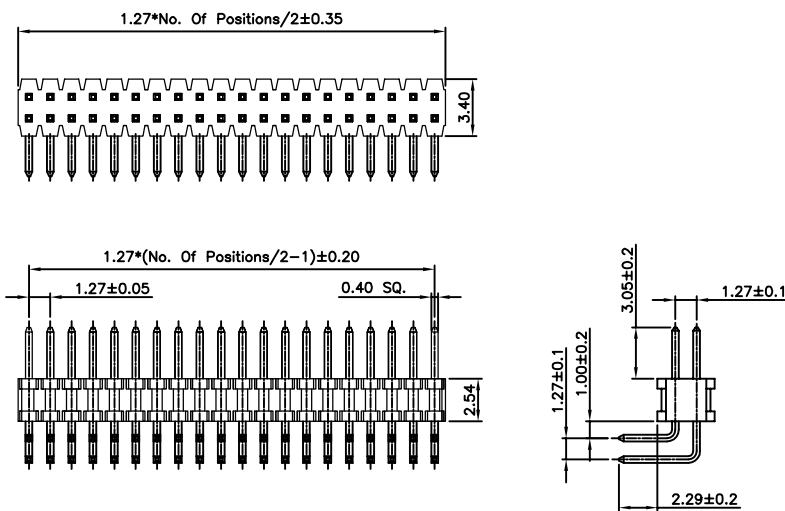

Specifications

Rating

Current Rating:1.0 Amp
Voltage Rating:100V AC/DC
Operating Temperature Range:-40°~+105°C

Electrical

Contact resistance:20m Ohm Max
Insulator resistance:500M ohm min.
Withstanding Voltage:500V AC/Minute

Material And Finish

Insulator:Nylon 6T UL94V-0 Color:Black
Contact:Brass
Plated:Gold Flash Over Nickel

No.of CKTS	Part No.	No.of CKTS	Part No.
04	0413032-040101	54	0413032-540101
06	0413032-060101	56	0413032-560101
08	0413032-080101	58	0413032-580101
10	0413032-100101	60	0413032-600101
12	0413032-120101	62	0413032-620101
14	0413032-140101	64	0413032-640101
16	0413032-160101	66	0413032-660101
18	0413032-180101	68	0413032-680101
20	0413032-200101	70	0413032-700101
22	0413032-220101	72	0413032-720101
24	0413032-240101	74	0413032-740101
26	0413032-260101	76	0413032-760101
28	0413032-280101	78	0413032-780101
30	0413032-300101	80	0413032-800101
32	0413032-320101	82	0413032-820101
34	0413032-340101	84	0413032-840101
36	0413032-360101	86	0413032-860101
38	0413032-380101	88	0413032-880101
40	0413032-400101	90	0413032-900101
42	0413032-420101	92	0413032-920101
44	0413032-440101	94	0413032-940101
46	0413032-460101	96	0413032-960101
48	0413032-480101	98	0413032-980101
50	0413032-500101	100	0413032-1000101
52	0413032-520101		

1.27mm(0.05") Pitch
Pin Header Connector

0413033
Vertical, SMT

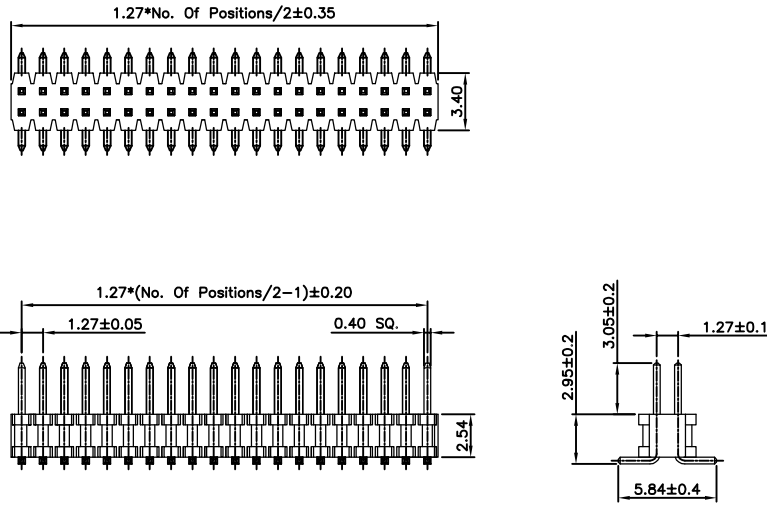

Specifications

Rating

Current Rating:1.0 Amp
Voltage Rating:100V AC/DC
Operating Temperature Range:-40°~+105°C

Electrical

Contact resistance:20m Ohm Max
Insulator resistance:500M ohm min.
Withstanding Voltage:500V AC/Minute

Material And Finish

Insulator:Nylon 6T UL94V-0 Color:Black
Contact:Brass
Plated:Gold Flash Over Nickel

No. of CKTS	Part No.	No. of CKTS	Part No.
04	0413033-040101	52	0413033-520101
06	0413033-060101	54	0413033-540101
08	0413033-080101	56	0413033-560101
10	0413033-100101	58	0413033-580101
12	0413033-120101	60	0413033-600101
14	0413033-140101	62	0413033-620101
16	0413033-160101	64	0413033-640101
18	0413033-180101	66	0413033-660101
20	0413033-200101	68	0413033-680101
22	0413033-220101	70	0413033-700101
24	0413033-240101	72	0413033-720101
26	0413033-260101	74	0413033-740101
28	0413033-280101	76	0413033-760101
30	0413033-300101	78	0413033-780101
32	0413033-320101	80	0413033-800101
34	0413033-340101	82	0413033-820101
36	0413033-360101	84	0413033-840101
38	0413033-380101	86	0413033-860101
40	0413033-400101	88	0413033-880101
42	0413033-420101	90	0413033-900101
44	0413033-440101	92	0413033-920101
46	0413033-460101	94	0413033-940101
48	0413033-480101	96	0413033-960101
50	0413033-500101	98	0413033-980101
		100	0413033-1000101

1.27mm(0.05") Pitch
Pin Header Connector

0413032
Vertical, SMT

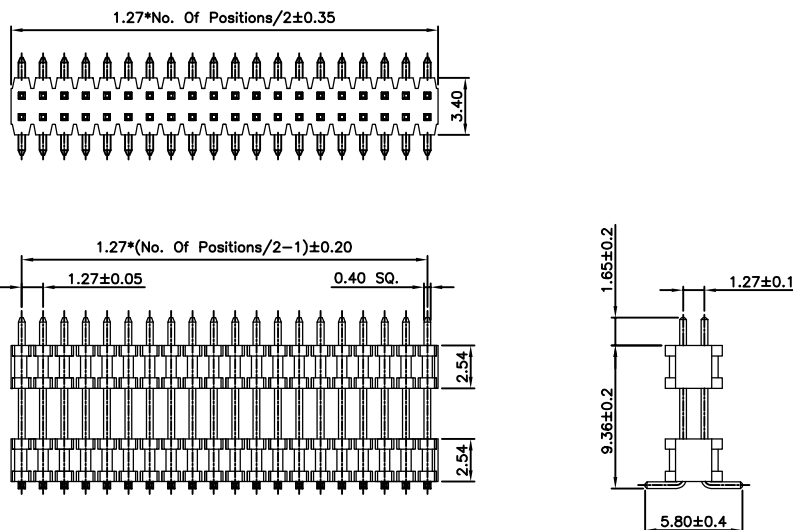

Specifications

Rating

Current Rating:1.0 Amp
Voltage Rating:100V AC/DC
Operating Temperature Range:-40°~+105°C

Electrical

Contact resistance:20m Ohm Max
Insulator resistance:500M ohm min.
Withstanding Voltage:500V AC/Minute

Material And Finish

Insulator:Nylon 6T UL94V-0 Color:Black
Contact:Brass
Plated:Gold Flash Over Nickel

No. of CKTS	Part No.	No. of CKTS	Part No.
04	04130332-040101	52	04130332-520101
06	04130332-060101	54	04130332-540101
08	04130332-080101	56	04130332-560101
10	04130332-100101	58	04130332-580101
12	04130332-120101	60	04130332-600101
14	04130332-140101	62	04130332-620101
16	04130332-160101	64	04130332-640101
18	04130332-180101	66	04130332-660101
20	04130332-200101	68	04130332-680101
22	04130332-220101	70	04130332-700101
24	04130332-240101	72	04130332-720101
26	04130332-260101	74	04130332-740101
28	04130332-280101	76	04130332-760101
30	04130332-300101	78	04130332-780101
32	04130332-320101	80	04130332-800101
34	04130332-340101	82	04130332-820101
36	04130332-360101	84	04130332-840101
38	04130332-380101	86	04130332-860101
40	04130332-400101	88	04130332-880101
42	04130332-420101	90	04130332-900101
44	04130332-440101	92	04130332-920101
46	04130332-460101	94	04130332-940101
48	04130332-480101	96	04130332-960101
50	04130332-500101	98	04130332-980101
		100	04130332-1000101

1.27mm(0.05") Pitch
Pin Header Connector

0413035

Right Angle, SMT

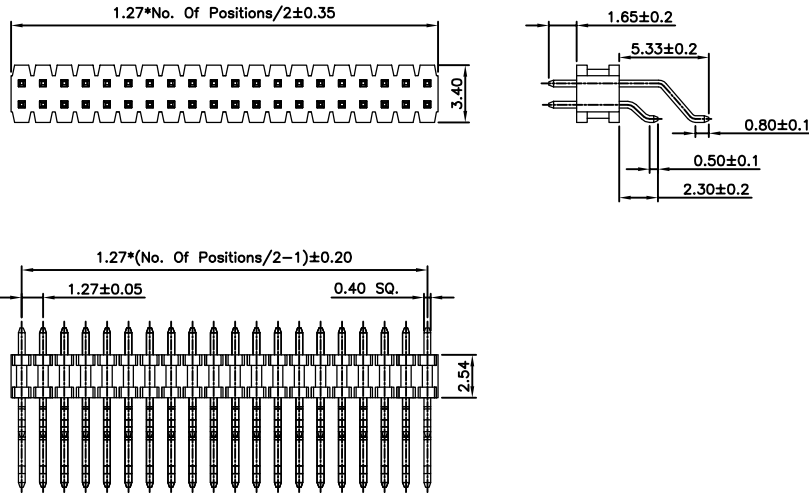

Specifications

Rating

Current Rating:1.0 Amp
Voltage Rating:100V AC/DC
Operating Temperature Range:-40°~+105°C

Electrical

Contact resistance:20m Ohm Max
Insulator resistance:500M ohm min.
Withstanding Voltage:500V AC/Minute

Material And Finish

Insulator:Nylon 6T UL94V-0 Color:Black
Contact:Brass
Plated:Gold Flash Over Nickel

No.of CKTS	Part No.	No.of CKTS	Part No.
04	0413035-040101	52	0413035-520101
06	0413035-060101	54	0413035-540101
08	0413035-080101	56	0413035-560101
10	0413035-100101	58	0413035-580101
12	0413035-120101	60	0413035-600101
14	0413035-140101	62	0413035-620101
16	0413035-160101	64	0413035-640101
18	0413035-180101	66	0413035-660101
20	0413035-200101	68	0413035-680101
22	0413035-220101	70	0413035-700101
24	0413035-240101	72	0413035-720101
26	0413035-260101	74	0413035-740101
28	0413035-280101	76	0413035-760101
30	0413035-300101	78	0413035-780101
32	0413035-320101	80	0413035-800101
34	0413035-340101	82	0413035-820101
36	0413035-360101	84	0413035-840101
38	0413035-380101	86	0413035-860101
40	0413035-400101	88	0413035-880101
42	0413035-420101	90	0413035-900101
44	0413035-440101	92	0413035-920101
46	0413035-460101	94	0413035-940101
48	0413035-480101	96	0413035-960101
50	0413035-500101	98	0413035-980101
		100	0413035-1000101

1.27mm(0.05") Pitch
Pin Header Connector

0413036

Right Angle, SMT

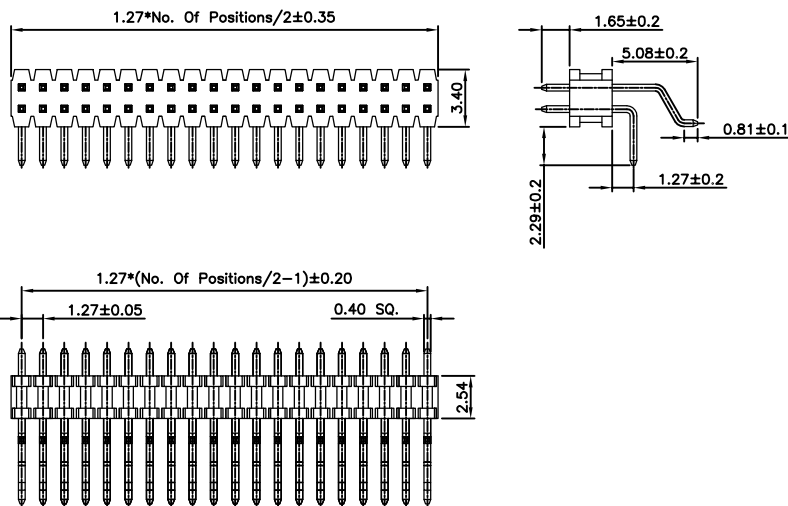

Specifications

Rating

Current Rating:1.0 Amp
Voltage Rating:100V AC/DC
Operating Temperature Range:-40°~+105°C

Electrical

Contact resistance:20m Ohm Max
Insulator resistance:500M ohm min.
Withstanding Voltage:500V AC/Minute

Material And Finish

Insulator:Nylon 6T UL94V-0 Color:Black
Contact:Brass
Plated:Gold Flash Over Nickel

No.of CKTS	Part No.	No.of CKTS	Part No.
04	0413036-040101	52	0413036-520101
06	0413036-060101	54	0413036-540101
08	0413036-080101	56	0413036-560101
10	0413036-100101	58	0413036-580101
12	0413036-120101	60	0413036-600101
14	0413036-140101	62	0413036-620101
16	0413036-160101	64	0413036-640101
18	0413036-180101	66	0413036-660101
20	0413036-200101	68	0413036-680101
22	0413036-220101	70	0413036-700101
24	0413036-240101	72	0413036-720101
26	0413036-260101	74	0413036-740101
28	0413036-280101	76	0413036-760101
30	0413036-300101	78	0413036-780101
32	0413036-320101	80	0413036-800101
34	0413036-340101	82	0413036-820101
36	0413036-360101	84	0413036-840101
38	0413036-380101	86	0413036-860101
40	0413036-400101	88	0413036-880101
42	0413036-420101	90	0413036-900101
44	0413036-440101	92	0413036-920101
46	0413036-460101	94	0413036-940101
48	0413036-480101	96	0413036-960101
50	0413036-500101	98	0413036-980101
		100	0413036-1000101

1.27mm(0.05") Pitch
Pin Header Connector

0413041
Vertical, Through Hole

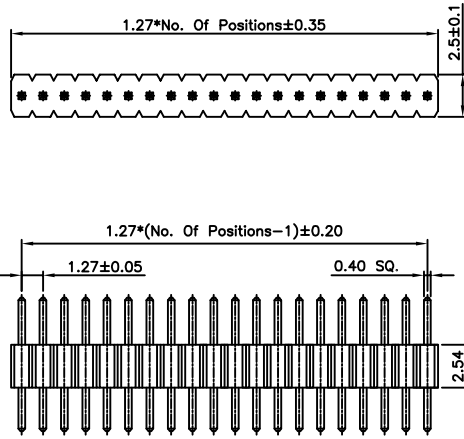

Specifications

Rating

Current Rating:1.0 Amp
Voltage Rating:100V AC/DC
Operating Temperature Range:-40~+105°C

Electrical

Contact resistance:20m Ohm Max
Insulator resistance:500M ohm min.
Withstanding Voltage:500V AC/Minute

Material And Finish

Insulator:Nylon 6T UL94V-0 Color:Black
Contact:Brass
Plated:Gold Flash Over Nickel

No.of CKTS	Part No.	No.of CKTS	Part No.
01	0413041-010100	26	0413041-260100
02	0413041-020100	27	0413041-270100
03	0413041-030100	28	0413041-280100
04	0413041-040100	29	0413041-290100
05	0413041-050100	30	0413041-300100
06	0413041-060100	31	0413041-310100
07	0413041-070100	32	0413041-320100
08	0413041-080100	33	0413041-330100
09	0413041-090100	34	0413041-340100
10	0413041-100100	35	0413041-350100
11	0413041-110100	36	0413041-360100
12	0413041-120100	37	0413041-370100
13	0413041-130100	38	0413041-380100
14	0413041-140100	39	0413041-390100
15	0413041-150100	40	0413041-400100
16	0413041-160100	41	0413041-410100
17	0413041-170100	42	0413041-420100
18	0413041-180100	43	0413041-430100
19	0413041-190100	44	0413041-440100
20	0413041-200100	45	0413041-450100
21	0413041-210100	46	0413041-460100
22	0413041-220100	47	0413041-470100
23	0413041-230100	48	0413041-480100
24	0413041-240100	49	0413041-490100
25	0413041-250100	50	0413041-500100

1.27mm(0.05") Pitch
Pin Header Connector

04130412
Vertical, Through Hole

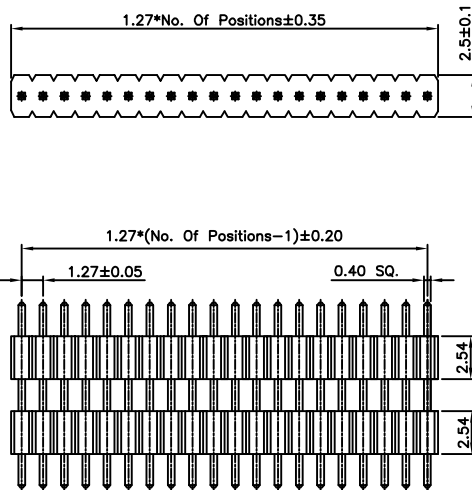

Specifications

Rating

Current Rating:1.0 Amp
Voltage Rating:100V AC/DC
Operating Temperature Range:-40~+105°C

Electrical

Contact resistance:20m Ohm Max
Insulator resistance:500M ohm min.
Withstanding Voltage:500V AC/Minute

Material And Finish

Insulator:Nylon 6T UL94V-0 Color:Black
Contact:Brass
Plated:Gold Flash Over Nickel

No.of CKTS	Part No.	No.of CKTS	Part No.
01	04130412-010100	26	04130412-260100
02	04130412-020100	27	04130412-270100
03	04130412-030100	28	04130412-280100
04	04130412-040100	29	04130412-290100
05	04130412-050100	30	04130412-300100
06	04130412-060100	31	04130412-310100
07	04130412-070100	32	04130412-320100
08	04130412-080100	33	04130412-330100
09	04130412-090100	34	04130412-340100
10	04130412-100100	35	04130412-350100
11	04130412-110100	36	04130412-360100
12	04130412-120100	37	04130412-370100
13	04130412-130100	38	04130412-380100
14	04130412-140100	39	04130412-390100
15	04130412-150100	40	04130412-400100
16	04130412-160100	41	04130412-410100
17	04130412-170100	42	04130412-420100
18	04130412-180100	43	04130412-430100
19	04130412-190100	44	04130412-440100
20	04130412-200100	45	04130412-450100
21	04130412-210100	46	04130412-460100
22	04130412-220100	47	04130412-470100
23	04130412-230100	48	04130412-480100
24	04130412-240100	49	04130412-490100
25	04130412-250100	50	04130412-500100

1.27mm(0.05") Pitch
Pin Header Connector

0413042
Right Angle, Through Hole

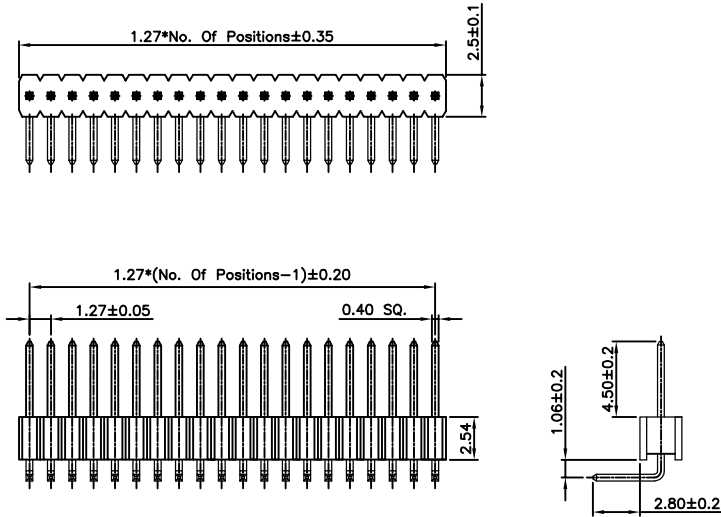

Specifications

Rating

Current Rating:1.0 Amp
Voltage Rating:100V AC/DC
Operating Temperature Range:-40~+105°C

Electrical

Contact resistance:20m Ohm Max
Insulator resistance:500M ohm min.
Withstanding Voltage:500V AC/Minute

Material And Finish

Insulator:Nylon 6T UL94V-0 Color:Black
Contact:Brass
Plated:Gold Flash Over Nickel

No.of CKTS	Part No.	No.of CKTS	Part No.
01	0413042-010100	26	0413042-260100
02	0413042-020100	27	0413042-270100
03	0413042-030100	28	0413042-280100
04	0413042-040100	29	0413042-290100
05	0413042-050100	30	0413042-300100
06	0413042-060100	31	0413042-310100
07	0413042-070100	32	0413042-320100
08	0413042-080100	33	0413042-330100
09	0413042-090100	34	0413042-340100
10	0413042-100100	35	0413042-350100
11	0413042-110100	36	0413042-360100
12	0413042-120100	37	0413042-370100
13	0413042-130100	38	0413042-380100
14	0413042-140100	39	0413042-390100
15	0413042-150100	40	0413042-400100
16	0413042-160100	41	0413042-410100
17	0413042-170100	42	0413042-420100
18	0413042-180100	43	0413042-430100
19	0413042-190100	44	0413042-440100
20	0413042-200100	45	0413042-450100
21	0413042-210100	46	0413042-460100
22	0413042-220100	47	0413042-470100
23	0413042-230100	48	0413042-480100
24	0413042-240100	49	0413042-490100
25	0413042-250100	50	0413042-500100

1.27mm(0.05") Pitch
Pin Header Connector

04130422
Right Angle, Through Hole

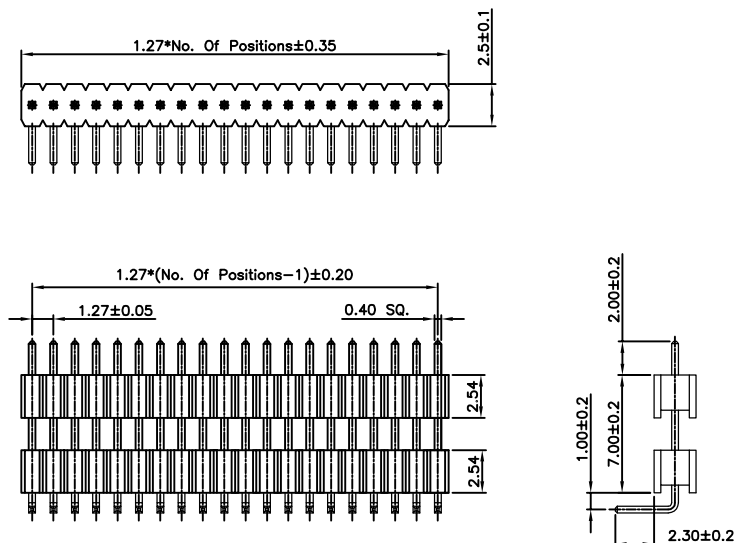

Specifications

Rating

Current Rating:1.0 Amp
Voltage Rating:100V AC/DC
Operating Temperature Range:-40~+105°C

Electrical

Contact resistance:20m Ohm Max
Insulator resistance:500M ohm min.
Withstanding Voltage:500V AC/Minute

Material And Finish

Insulator:Nylon 6T UL94V-0 Color:Black
Contact:Brass
Plated:Gold Flash Over Nickel

No.of CKTS	Part No.	No.of CKTS	Part No.
01	04130422-010100	26	04130422-260100
02	04130422-020100	27	04130422-270100
03	04130422-030100	28	04130422-280100
04	04130422-040100	29	04130422-290100
05	04130422-050100	30	04130422-300100
06	04130422-060100	31	04130422-310100
07	04130422-070100	32	04130422-320100
08	04130422-080100	33	04130422-330100
09	04130422-090100	34	04130422-340100
10	04130422-100100	35	04130422-350100
11	04130422-110100	36	04130422-360100
12	04130422-120100	37	04130422-370100
13	04130422-130100	38	04130422-380100
14	04130422-140100	39	04130422-390100
15	04130422-150100	40	04130422-400100
16	04130422-160100	41	04130422-410100
17	04130422-170100	42	04130422-420100
18	04130422-180100	43	04130422-430100
19	04130422-190100	44	04130422-440100
20	04130422-200100	45	04130422-450100
21	04130422-210100	46	04130422-460100
22	04130422-220100	47	04130422-470100
23	04130422-230100	48	04130422-480100
24	04130422-240100	49	04130422-490100
25	04130422-250100	50	04130422-500100

1.27mm(0.05") Pitch
Pin Header Connector

0413043
Vertical, SMT

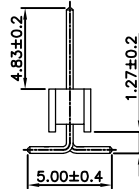
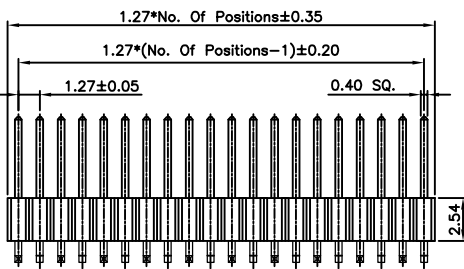
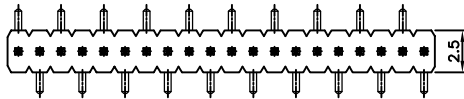

Specifications

Rating

Current Rating:1.0 Amp
Voltage Rating:100V AC/DC
Operating Temperature Range:-40~+105°C

Electrical

Contact resistance:20m Ohm Max
Insulator resistance:500M ohm min.
Withstanding Voltage:500V AC/Minute

Material And Finish

Insulator:Nylon 6T UL94V-0 Color:Black
Contact:Brass
Plated:Gold Flash Over Nickel

No.of CKTS	Part No.	No.of CKTS	Part No.
		26	0413043-260101
02	0413043-020101	27	0413043-270101
03	0413043-030101	28	0413043-280101
04	0413043-040101	29	0413043-290101
05	0413043-050101	30	0413043-300101
06	0413043-060101	31	0413043-310101
07	0413043-070101	32	0413043-320101
08	0413043-080101	33	0413043-330101
09	0413043-090101	34	0413043-340101
10	0413043-100101	35	0413043-350101
11	0413043-110101	36	0413043-360101
12	0413043-120101	37	0413043-370101
13	0413043-130101	38	0413043-380101
14	0413043-140101	39	0413043-390101
15	0413043-150101	40	0413043-400101
16	0413043-160101	41	0413043-410101
17	0413043-170101	42	0413043-420101
18	0413043-180101	43	0413043-430101
19	0413043-190101	44	0413043-440101
20	0413043-200101	45	0413043-450101
21	0413043-210101	46	0413043-460101
22	0413043-220101	47	0413043-470101
23	0413043-230101	48	0413043-480101
24	0413043-240101	49	0413043-490101
25	0413043-250101	50	0413043-500101

1.27mm(0.05") Pitch
Pin Header Connector

04130432
Vertical, SMT

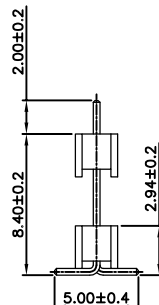
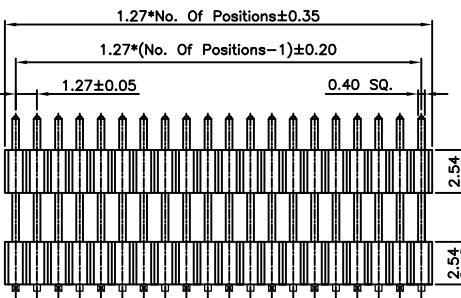
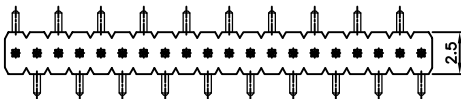

Specifications

Rating

Current Rating:1.0 Amp
Voltage Rating:100V AC/DC
Operating Temperature Range:-40~+105°C

Electrical

Contact resistance:20m Ohm Max
Insulator resistance:500M ohm min.
Withstanding Voltage:500V AC/Minute

Material And Finish

Insulator:Nylon 6T UL94V-0 Color:Black
Contact:Brass
Plated:Gold Flash Over Nickel

No.of CKTS	Part No.	No.of CKTS	Part No.
		26	04130432-260101
02	04130432-020101	27	04130432-270101
03	04130432-030101	28	04130432-280101
04	04130432-040101	29	04130432-290101
05	04130432-050101	30	04130432-300101
06	04130432-060101	31	04130432-310101
07	04130432-070101	32	04130432-320101
08	04130432-080101	33	04130432-330101
09	04130432-090101	34	04130432-340101
10	04130432-100101	35	04130432-350101
11	04130432-110101	36	04130432-360101
12	04130432-120101	37	04130432-370101
13	04130432-130101	38	04130432-380101
14	04130432-140101	39	04130432-390101
15	04130432-150101	40	04130432-400101
16	04130432-160101	41	04130432-410101
17	04130432-170101	42	04130432-420101
18	04130432-180101	43	04130432-430101
19	04130432-190101	44	04130432-440101
20	04130432-200101	45	04130432-450101
21	04130432-210101	46	04130432-460101
22	04130432-220101	47	04130432-470101
23	04130432-230101	48	04130432-480101
24	04130432-240101	49	04130432-490101
25	04130432-250101	50	04130432-500101

1.27mm(0.05") Pitch
Pin Header Connector

0413051
Vertical, Through Hole

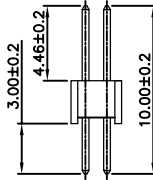
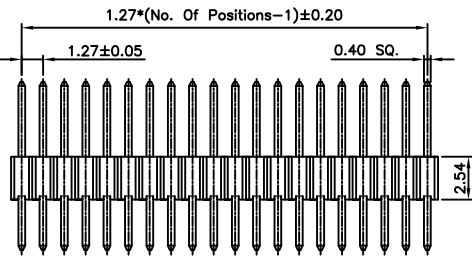
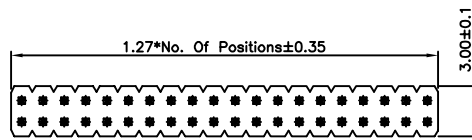

Specifications

Rating

Current Rating:1.0 Amp
Voltage Rating:100V AC/DC
Operating Temperature Range:-40°~+105°C

Electrical

Contact resistance:20m Ohm Max
Insulator resistance:500M ohm min.
Withstanding Voltage:500V AC/Minute

Material And Finish

Insulator:Nylon 6T UL94V-0 Color:Black
Contact:Brass
Plated:Gold Flash Over Nickel

No.of CKTS	Part No.	No.of CKTS	Part No.
04	0413051-040100	52	0413051-520100
06	0413051-060100	54	0413051-540100
08	0413051-080100	56	0413051-560100
10	0413051-100100	58	0413051-580100
12	0413051-120100	60	0413051-600100
14	0413051-140100	62	0413051-620100
16	0413051-160100	64	0413051-640100
18	0413051-180100	66	0413051-660100
20	0413051-200100	68	0413051-680100
22	0413051-220100	70	0413051-700100
24	0413051-240100	72	0413051-720100
26	0413051-260100	74	0413051-740100
28	0413051-280100	76	0413051-760100
30	0413051-300100	78	0413051-780100
32	0413051-320100	80	0413051-800100
34	0413051-340100	82	0413051-820100
36	0413051-360100	84	0413051-840100
38	0413051-380100	86	0413051-860100
40	0413051-400100	88	0413051-880100
42	0413051-420100	90	0413051-900100
44	0413051-440100	92	0413051-920100
46	0413051-460100	94	0413051-940100
48	0413051-480100	96	0413051-960100
50	0413051-500100	98	0413051-980100
		100	0413051-1000100

1.27mm(0.05") Pitch
Pin Header Connector

04130512
Vertical, Through Hole

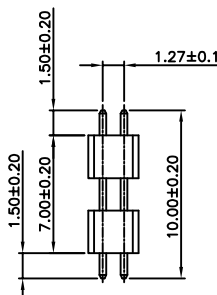
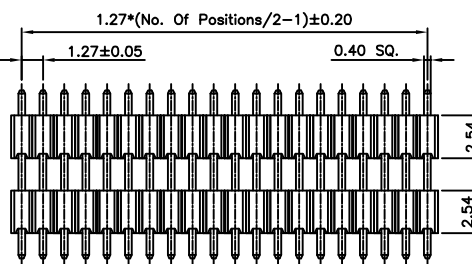
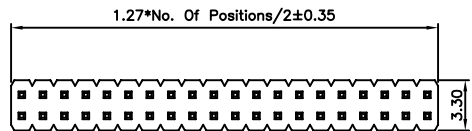

Specifications

Rating

Current Rating:1.0 Amp
Voltage Rating:100V AC/DC
Operating Temperature Range:-40°~+105°C

Electrical

Contact resistance:20m Ohm Max
Insulator resistance:500M ohm min.
Withstanding Voltage:500V AC/Minute

Material And Finish

Insulator:Nylon 6T UL94V-0 Color:Black
Contact:Brass
Plated:Gold Flash Over Nickel

No.of CKTS	Part No.	No.of CKTS	Part No.
04	04130512-040100	52	04130512-520100
06	04130512-060100	54	04130512-540100
08	04130512-080100	56	04130512-560100
10	04130512-100100	58	04130512-580100
12	04130512-120100	60	04130512-600100
14	04130512-140100	62	04130512-620100
16	04130512-160100	64	04130512-640100
18	04130512-180100	66	04130512-660100
20	04130512-200100	68	04130512-680100
22	04130512-220100	70	04130512-700100
24	04130512-240100	72	04130512-720100
26	04130512-260100	74	04130512-740100
28	04130512-280100	76	04130512-760100
30	04130512-300100	78	04130512-780100
32	04130512-320100	80	04130512-800100
34	04130512-340100	82	04130512-820100
36	04130512-360100	84	04130512-840100
38	04130512-380100	86	04130512-860100
40	04130512-400100	88	04130512-880100
42	04130512-420100	90	04130512-900100
44	04130512-440100	92	04130512-920100
46	04130512-460100	94	04130512-940100
48	04130512-480100	96	04130512-960100
50	04130512-500100	98	04130512-980100
		100	04130512-1000100

1.27mm(0.05") Pitch
Pin Header Connector

0413052
Right Angle, Through Hole

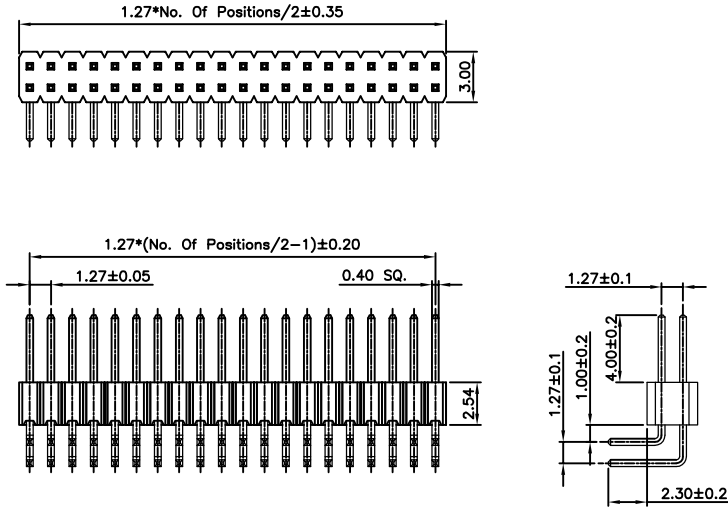

Specifications

Rating

Current Rating:1.0 Amp
Voltage Rating:100V AC/DC
Operating Temperature Range:-40~+105°C

Electrical

Contact resistance:20m Ohm Max
Insulator resistance:500M ohm min.
Withstanding Voltage:500V AC/Minute

Material And Finish

Insulator:Nylon 6T UL94V-0 Color:Black
Contact:Brass
Plated:Gold Flash Over Nickel

No.of CKTS	Part No.	No.of CKTS	Part No.
04	0413052-040100	52	0413052-520100
06	0413052-060100	54	0413052-540100
08	0413052-080100	56	0413052-560100
10	0413052-100100	58	0413052-580100
12	0413052-120100	60	0413052-600100
14	0413052-140100	62	0413052-620100
16	0413052-160100	64	0413052-640100
18	0413052-180100	66	0413052-660100
20	0413052-200100	68	0413052-680100
22	0413052-220100	70	0413052-700100
24	0413052-240100	72	0413052-720100
26	0413052-260100	74	0413052-740100
28	0413052-280100	76	0413052-760100
30	0413052-300100	78	0413052-780100
32	0413052-320100	80	0413052-800100
34	0413052-340100	82	0413052-820100
36	0413052-360100	84	0413052-840100
38	0413052-380100	86	0413052-860100
40	0413052-400100	88	0413052-880100
42	0413052-420100	90	0413052-900100
44	0413052-440100	92	0413052-920100
46	0413052-460100	94	0413052-940100
48	0413052-480100	96	0413052-960100
50	0413052-500100	98	0413052-980100
		100	0413052-1000100

1.27mm(0.05") Pitch
Pin Header Connector

0413053
Vertical, SMT

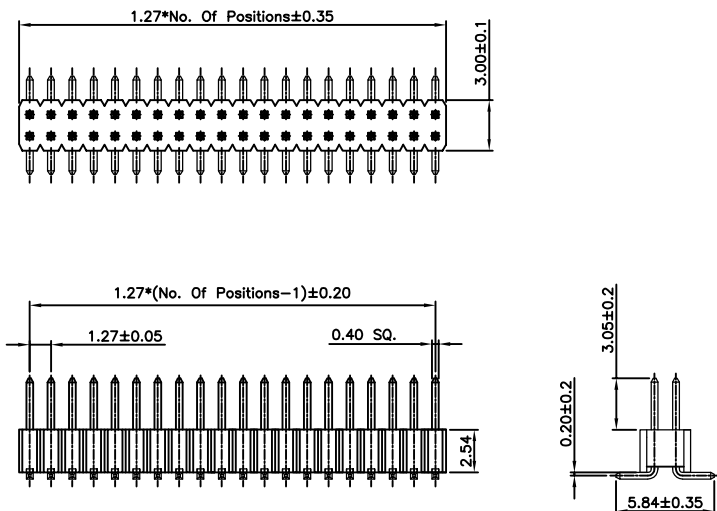

Specifications

Rating

Current Rating:1.0 Amp
Voltage Rating:100V AC/DC
Operating Temperature Range:-40~+105°C

Electrical

Contact resistance:20m Ohm Max
Insulator resistance:500M ohm min.
Withstanding Voltage:500V AC/Minute

Material And Finish

Insulator:Nylon 6T UL94V-0 Color:Black
Contact:Brass
Plated:Gold Flash Over Nickel

No.of CKTS	Part No.	No.of CKTS	Part No.
04	0413053-040101	52	0413053-520101
06	0413053-060101	54	0413053-540101
08	0413053-080101	56	0413053-560101
10	0413053-100101	58	0413053-580101
12	0413053-120101	60	0413053-600101
14	0413053-140101	62	0413053-620101
16	0413053-160101	64	0413053-640101
18	0413053-180101	66	0413053-660101
20	0413053-200101	68	0413053-680101
22	0413053-220101	70	0413053-700101
24	0413053-240101	72	0413053-720101
26	0413053-260101	74	0413053-740101
28	0413053-280101	76	0413053-760101
30	0413053-300101	78	0413053-780101
32	0413053-320101	80	0413053-800101
34	0413053-340101	82	0413053-820101
36	0413053-360101	84	0413053-840101
38	0413053-380101	86	0413053-860101
40	0413053-400101	88	0413053-880101
42	0413053-420101	90	0413053-900101
44	0413053-440101	92	0413053-920101
46	0413053-460101	94	0413053-940101
48	0413053-480101	96	0413053-960101
50	0413053-500101	98	0413053-980101
		100	0413053-1000101

1.50mm(0.059") Pitch
Pin Header Connector

0415011
Vertical, Through Hole

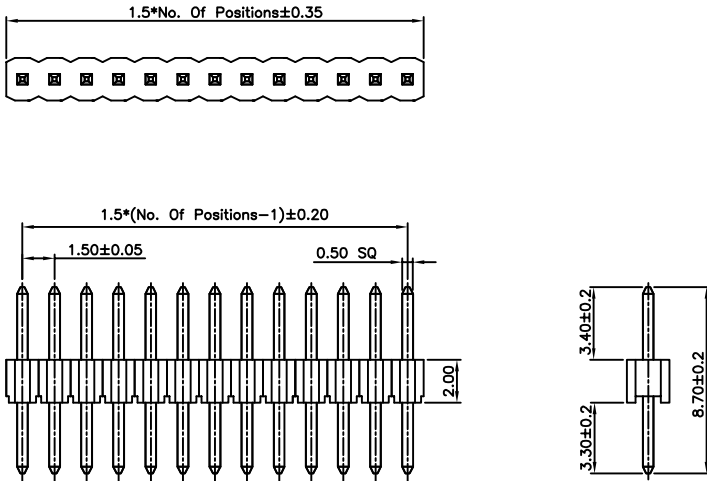

Specifications

Rating

Current Rating:1.0 Amp
Voltage Rating:100V AC/DC
Operating Temperature Range:-40°~+105°C

Electrical

Contact resistance:20m Ohm Max
Insulator resistance:1000M ohm min.
Withstanding Voltage:500V AC/Minute

Material And Finish

Insulator:Nylon 6T UL94V-0 Color:Black
Contact:Brass
Plated:Gold Flash Over Nickel

No.of CKTS	Part No.	No.of CKTS	Part No.
01	0415011-010100	26	0415011-260100
02	0415011-020100	27	0415011-270100
03	0415011-030100	28	0415011-280100
04	0415011-040100	29	0415011-290100
05	0415011-050100	30	0415011-300100
06	0415011-060100	31	0415011-310100
07	0415011-070100	32	0415011-320100
08	0415011-080100	33	0415011-330100
09	0415011-090100	34	0415011-340100
10	0415011-100100	35	0415011-350100
11	0415011-110100	36	0415011-360100
12	0415011-120100	37	0415011-370100
13	0415011-130100	38	0415011-380100
14	0415011-140100	39	0415011-390100
15	0415011-150100	40	0415011-400100
16	0415011-160100	41	0415011-410100
17	0415011-170100	42	0415011-420100
18	0415011-180100	43	0415011-430100
19	0415011-190100	44	0415011-440100
20	0415011-200100	45	0415011-450100
21	0415011-210100	46	0415011-460100
22	0415011-220100	47	0415011-470100
23	0415011-230100	48	0415011-480100
24	0415011-240100	49	0415011-490100
25	0415011-250100	50	0415011-500100

1.50mm(0.059") Pitch
Pin Header Connector

0415012
Right Angle, Through Hole

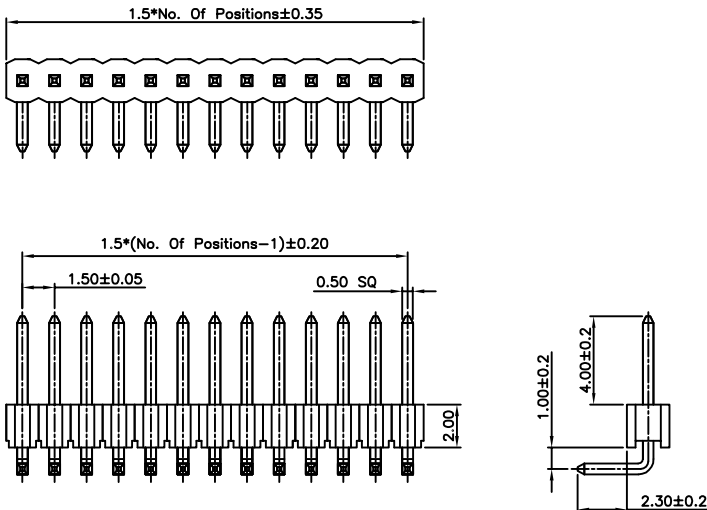

Specifications

Rating

Current Rating:1.0 Amp
Voltage Rating:100V AC/DC
Operating Temperature Range:-40°~+105°C

Electrical

Contact resistance:20m Ohm Max
Insulator resistance:1000M ohm min.
Withstanding Voltage:500V AC/Minute

Material And Finish

Insulator:Nylon 6T UL94V-0 Color:Black
Contact:Brass
Plated:Gold Flash Over Nickel

No.of CKTS	Part No.	No.of CKTS	Part No.
01	0415012-010100	26	0415012-260100
02	0415012-020100	27	0415012-270100
03	0415012-030100	28	0415012-280100
04	0415012-040100	29	0415012-290100
05	0415012-050100	30	0415012-300100
06	0415012-060100	31	0415012-310100
07	0415012-070100	32	0415012-320100
08	0415012-080100	33	0415012-330100
09	0415012-090100	34	0415012-340100
10	0415012-100100	35	0415012-350100
11	0415012-110100	36	0415012-360100
12	0415012-120100	37	0415012-370100
13	0415012-130100	38	0415012-380100
14	0415012-140100	39	0415012-390100
15	0415012-150100	40	0415012-400100
16	0415012-160100	41	0415012-410100
17	0415012-170100	42	0415012-420100
18	0415012-180100	43	0415012-430100
19	0415012-190100	44	0415012-440100
20	0415012-200100	45	0415012-450100
21	0415012-210100	46	0415012-460100
22	0415012-220100	47	0415012-470100
23	0415012-230100	48	0415012-480100
24	0415012-240100	49	0415012-490100
25	0415012-250100	50	0415012-500100

1.27mm(0.05") Pitch
Pin Header Connector

0413061
Vertical, Through Hole

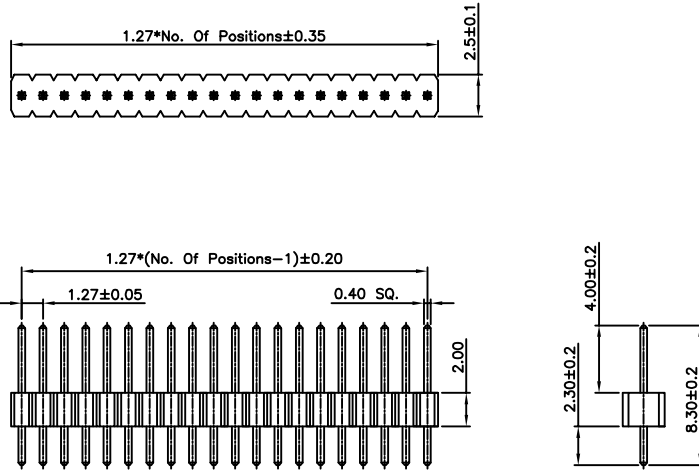

Specifications

Rating

Current Rating:1.0 Amp
Voltage Rating:100V AC/DC
Operating Temperature Range:-40°~+105°C

Electrical

Contact resistance:20m Ohm Max
Insulator resistance:500M ohm min.
Withstanding Voltage:500V AC/Minute

Material And Finish

Insulator:Nylon 6T UL94V-0 Color:Black
Contact:Brass
Plated:Gold Flash Over Nickel

No.of CKTS	Part No.	No.of CKTS	Part No.
01	0413061-010100	26	0413061-260100
02	0413061-020100	27	0413061-270100
03	0413061-030100	28	0413061-280100
04	0413061-040100	29	0413061-290100
05	0413061-050100	30	0413061-300100
06	0413061-060100	31	0413061-310100
07	0413061-070100	32	0413061-320100
08	0413061-080100	33	0413061-330100
09	0413061-090100	34	0413061-340100
10	0413061-100100	35	0413061-350100
11	0413061-110100	36	0413061-360100
12	0413061-120100	37	0413061-370100
13	0413061-130100	38	0413061-380100
14	0413061-140100	39	0413061-390100
15	0413061-150100	40	0413061-400100
16	0413061-160100	41	0413061-410100
17	0413061-170100	42	0413061-420100
18	0413061-180100	43	0413061-430100
19	0413061-190100	44	0413061-440100
20	0413061-200100	45	0413061-450100
21	0413061-210100	46	0413061-460100
22	0413061-220100	47	0413061-470100
23	0413061-230100	48	0413061-480100
24	0413061-240100	49	0413061-490100
25	0413061-250100	50	0413061-500100

1.27mm(0.05") Pitch
Pin Header Connector

04130612
Vertical, Through Hole

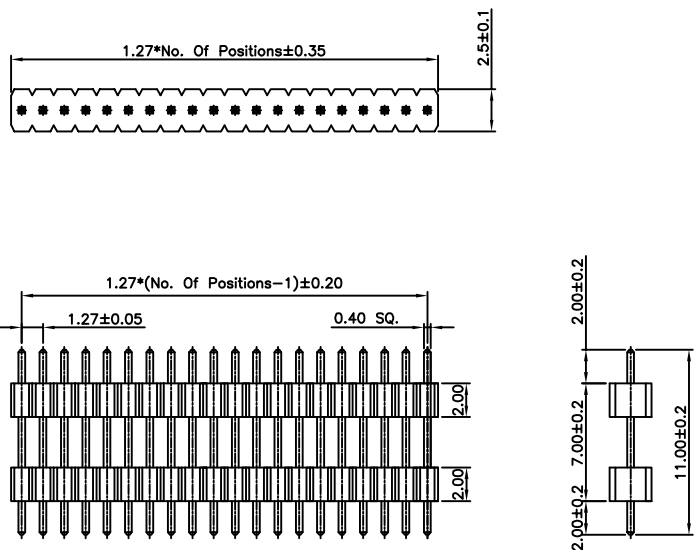

Specifications

Rating

Current Rating:1.0 Amp
Voltage Rating:100V AC/DC
Operating Temperature Range:-40°~+105°C

Electrical

Contact resistance:20m Ohm Max
Insulator resistance:500M ohm min.
Withstanding Voltage:500V AC/Minute

Material And Finish

Insulator:Nylon 6T UL94V-0 Color:Black
Contact:Brass
Plated:Gold Flash Over Nickel

No.of CKTS	Part No.	No.of CKTS	Part No.
01	04130612-010100	26	04130612-260100
02	04130612-020100	27	04130612-270100
03	04130612-030100	28	04130612-280100
04	04130612-040100	29	04130612-290100
05	04130612-050100	30	04130612-300100
06	04130612-060100	31	04130612-310100
07	04130612-070100	32	04130612-320100
08	04130612-080100	33	04130612-330100
09	04130612-090100	34	04130612-340100
10	04130612-100100	35	04130612-350100
11	04130612-110100	36	04130612-360100
12	04130612-120100	37	04130612-370100
13	04130612-130100	38	04130612-380100
14	04130612-140100	39	04130612-390100
15	04130612-150100	40	04130612-400100
16	04130612-160100	41	04130612-410100
17	04130612-170100	42	04130612-420100
18	04130612-180100	43	04130612-430100
19	04130612-190100	44	04130612-440100
20	04130612-200100	45	04130612-450100
21	04130612-210100	46	04130612-460100
22	04130612-220100	47	04130612-470100
23	04130612-230100	48	04130612-480100
24	04130612-240100	49	04130612-490100
25	04130612-250100	50	04130612-500100

1.27mm(0.05") Pitch
Pin Header Connector

0413062
Right Angle, Through Hole

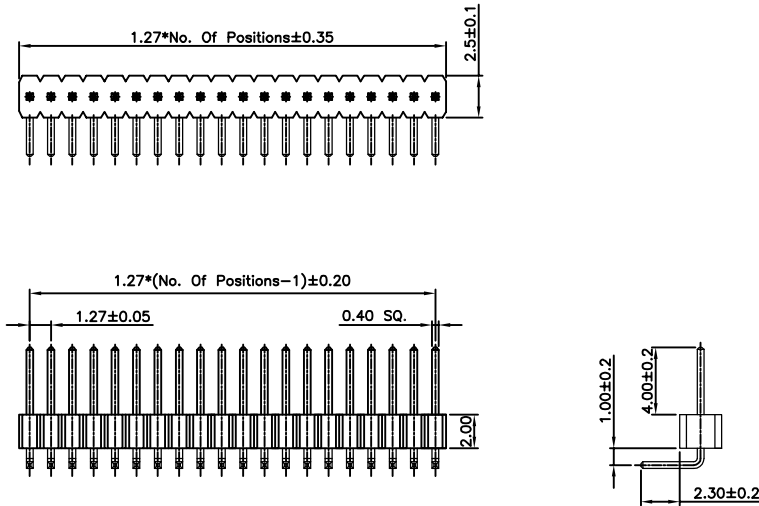

Specifications

Rating

Current Rating:1.0 Amp
Voltage Rating:100V AC/DC
Operating Temperature Range:-40°~+105°C

Electrical

Contact resistance:20m Ohm Max
Insulator resistance:500M ohm min.
Withstanding Voltage:500V AC/Minute

Material And Finish

Insulator:Nylon 6T UL94V-0 Color:Black
Contact:Brass
Plated:Gold Flash Over Nickel

No.of CKTS	Part No.	No.of CKTS	Part No.
01	0413062-010100	26	0413062-260100
02	0413062-020100	27	0413062-270100
03	0413062-030100	28	0413062-280100
04	0413062-040100	29	0413062-290100
05	0413062-050100	30	0413062-300100
06	0413062-060100	31	0413062-310100
07	0413062-070100	32	0413062-320100
08	0413062-080100	33	0413062-330100
09	0413062-090100	34	0413062-340100
10	0413062-100100	35	0413062-350100
11	0413062-110100	36	0413062-360100
12	0413062-120100	37	0413062-370100
13	0413062-130100	38	0413062-380100
14	0413062-140100	39	0413062-390100
15	0413062-150100	40	0413062-400100
16	0413062-160100	41	0413062-410100
17	0413062-170100	42	0413062-420100
18	0413062-180100	43	0413062-430100
19	0413062-190100	44	0413062-440100
20	0413062-200100	45	0413062-450100
21	0413062-210100	46	0413062-460100
22	0413062-220100	47	0413062-470100
23	0413062-230100	48	0413062-480100
24	0413062-240100	49	0413062-490100
25	0413062-250100	50	0413062-500100

1.27mm(0.05") Pitch
Pin Header Connector

04130622
Right Angle, Through Hole

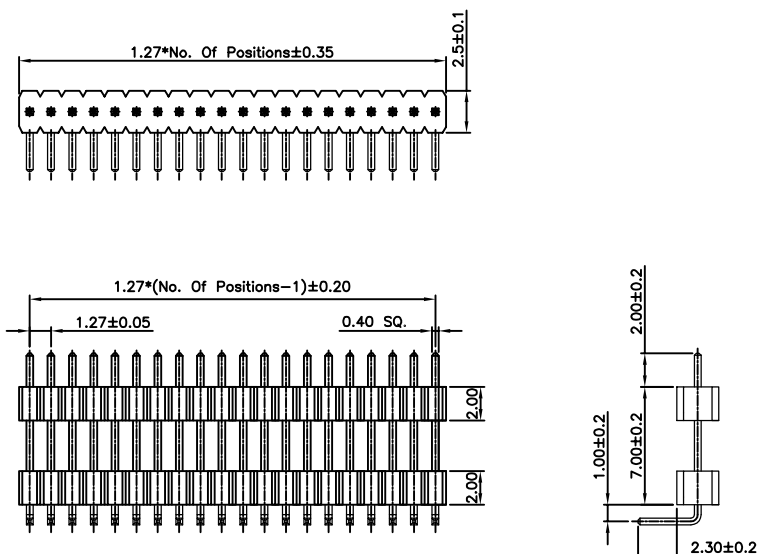

Specifications

Rating

Current Rating:1.0 Amp
Voltage Rating:100V AC/DC
Operating Temperature Range:-40°~+105°C

Electrical

Contact resistance:20m Ohm Max
Insulator resistance:500M ohm min.
Withstanding Voltage:500V AC/Minute

Material And Finish

Insulator:Nylon 6T UL94V-0 Color:Black
Contact:Brass
Plated:Gold Flash Over Nickel

No.of CKTS	Part No.	No.of CKTS	Part No.
01	04130622-010100	26	04130622-260100
02	04130622-020100	27	04130622-270100
03	04130622-030100	28	04130622-280100
04	04130622-040100	29	04130622-290100
05	04130622-050100	30	04130622-300100
06	04130622-060100	31	04130622-310100
07	04130622-070100	32	04130622-320100
08	04130622-080100	33	04130622-330100
09	04130622-090100	34	04130622-340100
10	04130622-100100	35	04130622-350100
11	04130622-110100	36	04130622-360100
12	04130622-120100	37	04130622-370100
13	04130622-130100	38	04130622-380100
14	04130622-140100	39	04130622-390100
15	04130622-150100	40	04130622-400100
16	04130622-160100	41	04130622-410100
17	04130622-170100	42	04130622-420100
18	04130622-180100	43	04130622-430100
19	04130622-190100	44	04130622-440100
20	04130622-200100	45	04130622-450100
21	04130622-210100	46	04130622-460100
22	04130622-220100	47	04130622-470100
23	04130622-230100	48	04130622-480100
24	04130622-240100	49	04130622-490100
25	04130622-250100	50	04130622-500100

1.27mm(0.05") Pitch
Pin Header Connector

0413071
Vertical, Through Hole

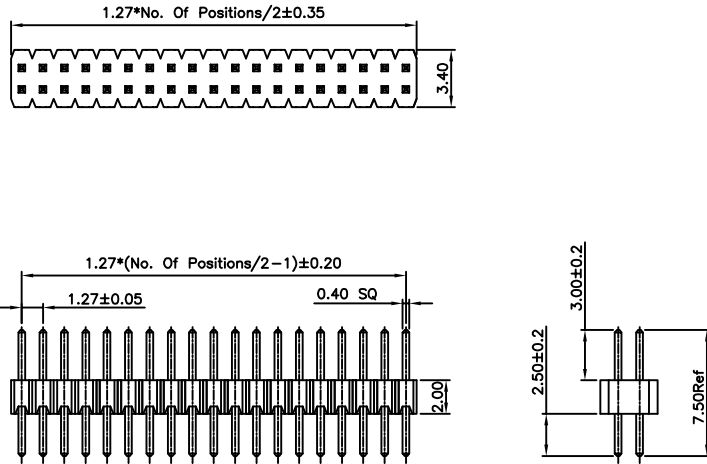

Specifications

Rating

Current Rating:1.0 Amp
Voltage Rating:100V AC/DC
Operating Temperature Range:-40°~+105°C

Electrical

Contact resistance:20m Ohm Max
Insulator resistance:500M ohm min.
Withstanding Voltage:500V AC/Minute

Material And Finish

Insulator:Nylon 6T UL94V-0 Color:Black
Contact:Brass
Plated:Gold Flash Over Nickel

No.of CKTS	Part No.	No.of CKTS	Part No.
04	0413071-040100	52	0413071-520100
06	0413071-060100	54	0413071-540100
08	0413071-080100	56	0413071-560100
10	0413071-100100	58	0413071-580100
12	0413071-120100	60	0413071-600100
14	0413071-140100	62	0413071-620100
16	0413071-160100	64	0413071-640100
18	0413071-180100	66	0413071-660100
20	0413071-200100	68	0413071-680100
22	0413071-220100	70	0413071-700100
24	0413071-240100	72	0413071-720100
26	0413071-260100	74	0413071-740100
28	0413071-280100	76	0413071-760100
30	0413071-300100	78	0413071-780100
32	0413071-320100	80	0413071-800100
34	0413071-340100	82	0413071-820100
36	0413071-360100	84	0413071-840100
38	0413071-380100	86	0413071-860100
40	0413071-400100	88	0413071-880100
42	0413071-420100	90	0413071-900100
44	0413071-440100	92	0413071-920100
46	0413071-460100	94	0413071-940100
48	0413071-480100	96	0413071-960100
50	0413071-500100	98	0413071-980100
		100	0413071-1000100

1.27mm(0.05") Pitch
Pin Header Connector

0413081
Vertical, Through Hole

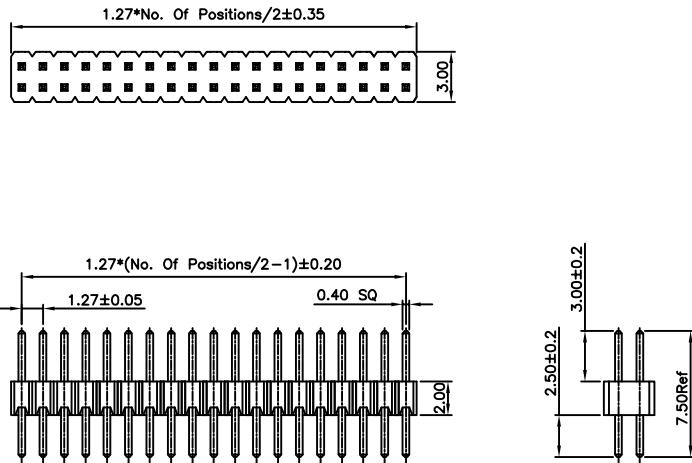

Specifications

Rating

Current Rating:1.0 Amp
Voltage Rating:100V AC/DC
Operating Temperature Range:-40°~+105°C

Electrical

Contact resistance:20m Ohm Max
Insulator resistance:500M ohm min.
Withstanding Voltage:500V AC/Minute

Material And Finish

Insulator:Nylon 6T UL94V-0 Color:Black
Contact:Brass
Plated:Gold Flash Over Nickel

No.of CKTS	Part No.	No.of CKTS	Part No.
04	0413081-040100	52	0413081-520100
06	0413081-060100	54	0413081-540100
08	0413081-080100	56	0413081-560100
10	0413081-100100	58	0413081-580100
12	0413081-120100	60	0413081-600100
14	0413081-140100	62	0413081-620100
16	0413081-160100	64	0413081-640100
18	0413081-180100	66	0413081-660100
20	0413081-200100	68	0413081-680100
22	0413081-220100	70	0413081-700100
24	0413081-240100	72	0413081-720100
26	0413081-260100	74	0413081-740100
28	0413081-280100	76	0413081-760100
30	0413081-300100	78	0413081-780100
32	0413081-320100	80	0413081-800100
34	0413081-340100	82	0413081-820100
36	0413081-360100	84	0413081-840100
38	0413081-380100	86	0413081-860100
40	0413081-400100	88	0413081-880100
42	0413081-420100	90	0413081-900100
44	0413081-440100	92	0413081-920100
46	0413081-460100	94	0413081-940100
48	0413081-480100	96	0413081-960100
50	0413081-500100	98	0413081-980100
		100	0413081-1000100

1.27mm(0.05") Pitch
Pin Header Connector

04130812

Vertical, Through Hole

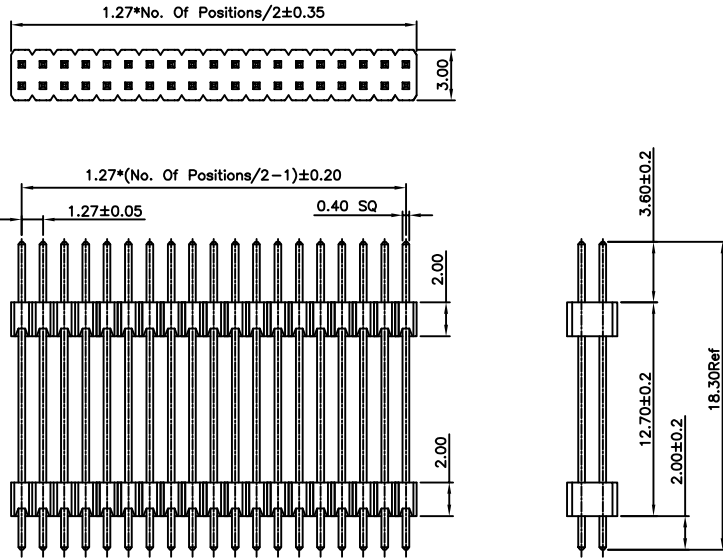

Specifications

Rating

Current Rating:1.0 Amp
Voltage Rating:100V AC/DC
Operating Temperature Range:-40°~+105°C

Electrical

Contact resistance:20m Ohm Max
Insulator resistance:500M ohm min.
Withstanding Voltage:500V AC/Minute

Material And Finish

Insulator:Nylon 6T UL94V-0 Color:Black
Contact:Brass
Plated:Gold Flash Over Nickel

No.of CKTS	Part No.	No.of CKTS	Part No.
04	04130812-040100	52	04130812-520100
06	04130812-060100	54	04130812-540100
08	04130812-080100	56	04130812-560100
10	04130812-100100	58	04130812-580100
12	04130812-120100	60	04130812-600100
14	04130812-140100	62	04130812-620100
16	04130812-160100	64	04130812-640100
18	04130812-180100	66	04130812-660100
20	04130812-200100	68	04130812-680100
22	04130812-220100	70	04130812-700100
24	04130812-240100	72	04130812-720100
26	04130812-260100	74	04130812-740100
28	04130812-280100	76	04130812-760100
30	04130812-300100	78	04130812-780100
32	04130812-320100	80	04130812-800100
34	04130812-340100	82	04130812-820100
36	04130812-360100	84	04130812-840100
38	04130812-380100	86	04130812-860100
40	04130812-400100	88	04130812-880100
42	04130812-420100	90	04130812-900100
44	04130812-440100	92	04130812-920100
46	04130812-460100	94	04130812-940100
48	04130812-480100	96	04130812-960100
50	04130812-500100	98	04130812-980100
		100	04130812-1000100

1.27mm(0.05") Pitch
Pin Header Connector

0413082

Right Angle, Through Hole

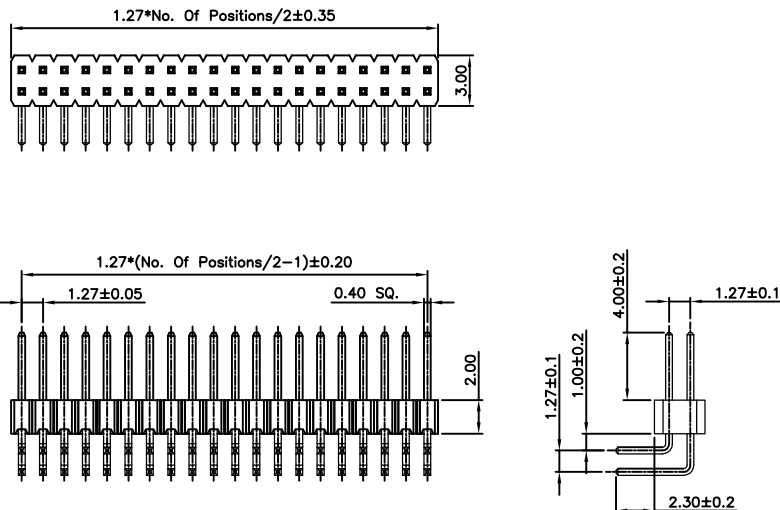

Specifications

Rating

Current Rating:1.0 Amp
Voltage Rating:100V AC/DC
Operating Temperature Range:-40°~+105°C

Electrical

Contact resistance:20m Ohm Max
Insulator resistance:500M ohm min.
Withstanding Voltage:500V AC/Minute

Material And Finish

Insulator:Nylon 6T UL94V-0 Color:Black
Contact:Brass
Plated:Gold Flash Over Nickel

No.of CKTS	Part No.	No.of CKTS	Part No.
04	0413082-040100	52	0413082-520100
06	0413082-060100	54	0413082-540100
08	0413082-080100	56	0413082-560100
10	0413082-100100	58	0413082-580100
12	0413082-120100	60	0413082-600100
14	0413082-140100	62	0413082-620100
16	0413082-160100	64	0413082-640100
18	0413082-180100	66	0413082-660100
20	0413082-200100	68	0413082-680100
22	0413082-220100	70	0413082-700100
24	0413082-240100	72	0413082-720100
26	0413082-260100	74	0413082-740100
28	0413082-280100	76	0413082-760100
30	0413082-300100	78	0413082-780100
32	0413082-320100	80	0413082-800100
34	0413082-340100	82	0413082-820100
36	0413082-360100	84	0413082-840100
38	0413082-380100	86	0413082-860100
40	0413082-400100	88	0413082-880100
42	0413082-420100	90	0413082-900100
44	0413082-440100	92	0413082-920100
46	0413082-460100	94	0413082-940100
48	0413082-480100	96	0413082-960100
50	0413082-500100	98	0413082-980100
		100	0413082-1000100

1.27mm(0.05") Pitch
Pin Header Connector

0413083
Vertical, SMT

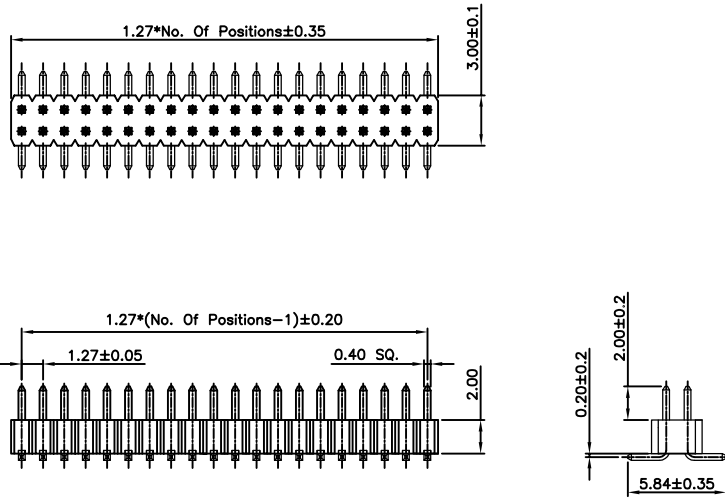

Specifications

Rating

Current Rating:1.0 Amp
Voltage Rating:100V AC/DC
Operating Temperature Range:-40°~+105°C

Electrical

Contact resistance:20m Ohm Max
Insulator resistance:500M ohm min.
Withstanding Voltage:500V AC/Minute

Material And Finish

Insulator:Nylon 6T UL94V-0 Color:Black
Contact:Brass
Plated:Gold Flash Over Nickel

No.of CKTS	Part No.	No.of CKTS	Part No.
04	0413083-040101	52	0413083-520101
06	0413083-060101	54	0413083-540101
08	0413083-080101	56	0413083-560101
10	0413083-100101	58	0413083-580101
12	0413083-120101	60	0413083-600101
14	0413083-140101	62	0413083-620101
16	0413083-160101	64	0413083-640101
18	0413083-180101	66	0413083-660101
20	0413083-200101	68	0413083-680101
22	0413083-220101	70	0413083-700101
24	0413083-240101	72	0413083-720101
26	0413083-260101	74	0413083-740101
28	0413083-280101	76	0413083-760101
30	0413083-300101	78	0413083-780101
32	0413083-320101	80	0413083-800101
34	0413083-340101	82	0413083-820101
36	0413083-360101	84	0413083-840101
38	0413083-380101	86	0413083-860101
40	0413083-400101	88	0413083-880101
42	0413083-420101	90	0413083-900101
44	0413083-440101	92	0413083-920101
46	0413083-460101	94	0413083-940101
48	0413083-480101	96	0413083-960101
50	0413083-500101	98	0413083-980101
		100	0413083-1000101

1.27mm(0.05") Pitch
Pin Header Connector

04130832
Vertical, SMT

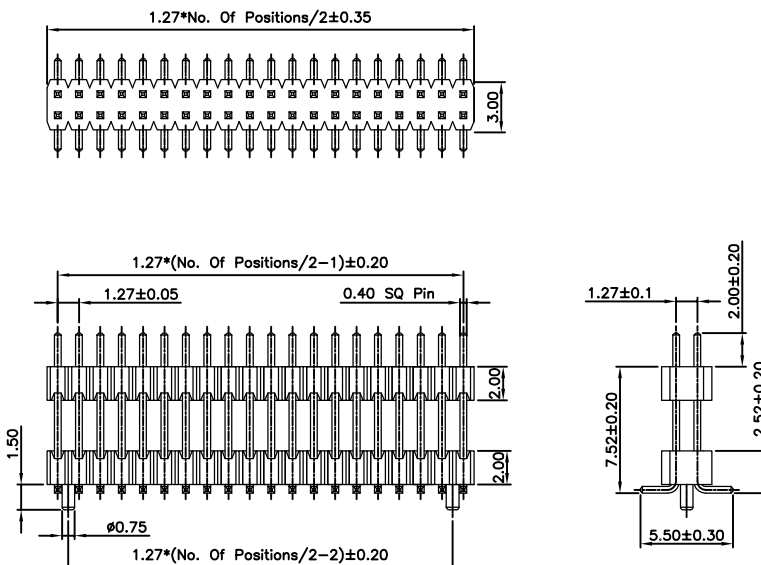

Specifications

Rating

Current Rating:1.0 Amp
Voltage Rating:100V AC/DC
Operating Temperature Range:-40°~+105°C

Electrical

Contact resistance:20m Ohm Max
Insulator resistance:500M ohm min.
Withstanding Voltage:500V AC/Minute

Material And Finish

Insulator:Nylon 6T UL94V-0 Color:Black
Contact:Brass
Plated:Gold Flash Over Nickel

No.of CKTS	Part No.	No.of CKTS	Part No.
04	04130832-040101	52	04130832-520101
06	04130832-060101	54	04130832-540101
08	04130832-080101	56	04130832-560101
10	04130832-100101	58	04130832-580101
12	04130832-120101	60	04130832-600101
14	04130832-140101	62	04130832-620101
16	04130832-160101	64	04130832-640101
18	04130832-180101	66	04130832-660101
20	04130832-200101	68	04130832-680101
22	04130832-220101	70	04130832-700101
24	04130832-240101	72	04130832-720101
26	04130832-260101	74	04130832-740101
28	04130832-280101	76	04130832-760101
30	04130832-300101	78	04130832-780101
32	04130832-320101	80	04130832-800101
34	04130832-340101	82	04130832-820101
36	04130832-360101	84	04130832-840101
38	04130832-380101	86	04130832-860101
40	04130832-400101	88	04130832-880101
42	04130832-420101	90	04130832-900101
44	04130832-440101	92	04130832-920101
46	04130832-460101	94	04130832-940101
48	04130832-480101	96	04130832-960101
50	04130832-500101	98	04130832-980101
		100	04130832-1000101

1.27mm(0.05") Pitch
Pin Header Connector

0413091
Vertical, Through Hole

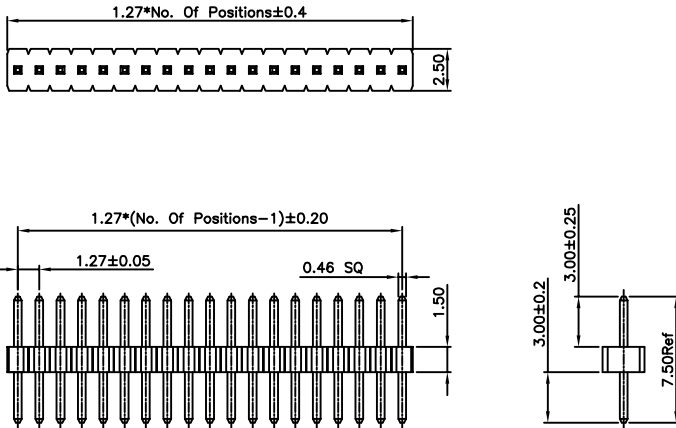

Specifications

Rating

Current Rating:1.0 Amp
Voltage Rating:100V AC/DC
Operating Temperature Range:-40°~+105°C

Electrical

Contact resistance:20m Ohm Max
Insulator resistance:500M ohm min.
Withstanding Voltage:500V AC/Minute

Material And Finish

Insulator:Nylon 6T UL94V-0 Color:Black
Contact:Brass
Plated:Gold Flash Over Nickel

No.of CKTS	Part No.	No.of CKTS	Part No.
01	0413091-010100	26	0413091-260100
02	0413091-020100	27	0413091-270100
03	0413091-030100	28	0413091-280100
04	0413091-040100	29	0413091-290100
05	0413091-050100	30	0413091-300100
06	0413091-060100	31	0413091-310100
07	0413091-070100	32	0413091-320100
08	0413091-080100	33	0413091-330100
09	0413091-090100	34	0413091-340100
10	0413091-100100	35	0413091-350100
11	0413091-110100	36	0413091-360100
12	0413091-120100	37	0413091-370100
13	0413091-130100	38	0413091-380100
14	0413091-140100	39	0413091-390100
15	0413091-150100	40	0413091-400100
16	0413091-160100	41	0413091-410100
17	0413091-170100	42	0413091-420100
18	0413091-180100	43	0413091-430100
19	0413091-190100	44	0413091-440100
20	0413091-200100	45	0413091-450100
21	0413091-210100	46	0413091-460100
22	0413091-220100	47	0413091-470100
23	0413091-230100	48	0413091-480100
24	0413091-240100	49	0413091-490100
25	0413091-250100	50	0413091-500100

1.27mm(0.05") Pitch
Pin Header Connector

0413101
Vertical, Through Hole

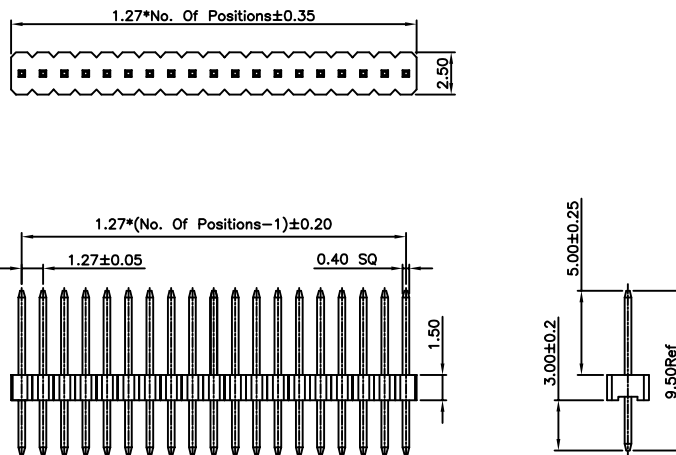

Specifications

Rating

Current Rating:1.0 Amp
Voltage Rating:100V AC/DC
Operating Temperature Range:-40°~+105°C

Electrical

Contact resistance:20m Ohm Max
Insulator resistance:500M ohm min.
Withstanding Voltage:500V AC/Minute

Material And Finish

Insulator:Nylon 6T UL94V-0 Color:Black
Contact:Brass
Plated:Gold Flash Over Nickel

No.of CKTS	Part No.	No.of CKTS	Part No.
01	0413101-010100	26	0413101-260100
02	0413101-020100	27	0413101-270100
03	0413101-030100	28	0413101-280100
04	0413101-040100	29	0413101-290100
05	0413101-050100	30	0413101-300100
06	0413101-060100	31	0413101-310100
07	0413101-070100	32	0413101-320100
08	0413101-080100	33	0413101-330100
09	0413101-090100	34	0413101-340100
10	0413101-100100	35	0413101-350100
11	0413101-110100	36	0413101-360100
12	0413101-120100	37	0413101-370100
13	0413101-130100	38	0413101-380100
14	0413101-140100	39	0413101-390100
15	0413101-150100	40	0413101-400100
16	0413101-160100	41	0413101-410100
17	0413101-170100	42	0413101-420100
18	0413101-180100	43	0413101-430100
19	0413101-190100	44	0413101-440100
20	0413101-200100	45	0413101-450100
21	0413101-210100	46	0413101-460100
22	0413101-220100	47	0413101-470100
23	0413101-230100	48	0413101-480100
24	0413101-240100	49	0413101-490100
25	0413101-250100	50	0413101-500100

1.27mm(0.05") Pitch
Pin Header Connector

04131012
Vertical, Through Hole

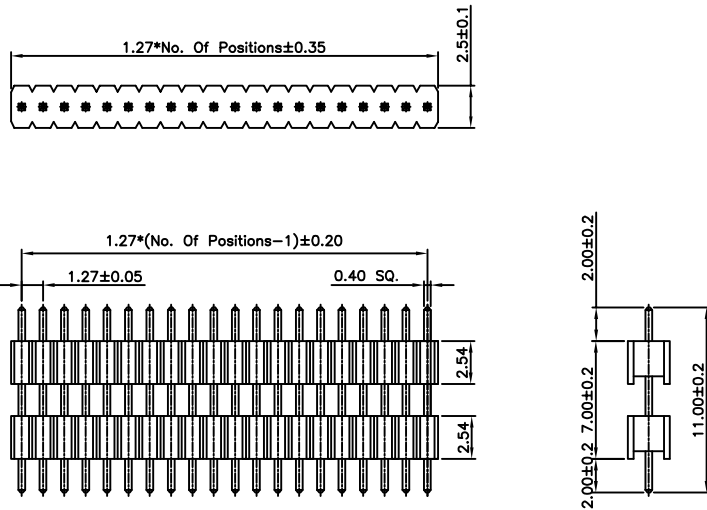

Specifications

Rating

Current Rating:1.0 Amp
Voltage Rating:100V AC/DC
Operating Temperature Range:-40°~+105°C

Electrical

Contact resistance:20m Ohm Max
Insulator resistance:500M ohm min.
Withstanding Voltage:500V AC/Minute

Material And Finish

Insulator:Nylon 6T UL94V-0 Color:Black
Contact:Brass
Plated:Gold Flash Over Nickel

No.of CKTS	Part No.	No.of CKTS	Part No.
01	04131012-010100	26	04131012-260100
02	04131012-020100	27	04131012-270100
03	04131012-030100	28	04131012-280100
04	04131012-040100	29	04131012-290100
05	04131012-050100	30	04131012-300100
06	04131012-060100	31	04131012-310100
07	04131012-070100	32	04131012-320100
08	04131012-080100	33	04131012-330100
09	04131012-090100	34	04131012-340100
10	04131012-100100	35	04131012-350100
11	04131012-110100	36	04131012-360100
12	04131012-120100	37	04131012-370100
13	04131012-130100	38	04131012-380100
14	04131012-140100	39	04131012-390100
15	04131012-150100	40	04131012-400100
16	04131012-160100	41	04131012-410100
17	04131012-170100	42	04131012-420100
18	04131012-180100	43	04131012-430100
19	04131012-190100	44	04131012-440100
20	04131012-200100	45	04131012-450100
21	04131012-210100	46	04131012-460100
22	04131012-220100	47	04131012-470100
23	04131012-230100	48	04131012-480100
24	04131012-240100	49	04131012-490100
25	04131012-250100	50	04131012-500100

1.27mm(0.05") Pitch
Pin Header Connector

0413102
Right Angle, Through Hole

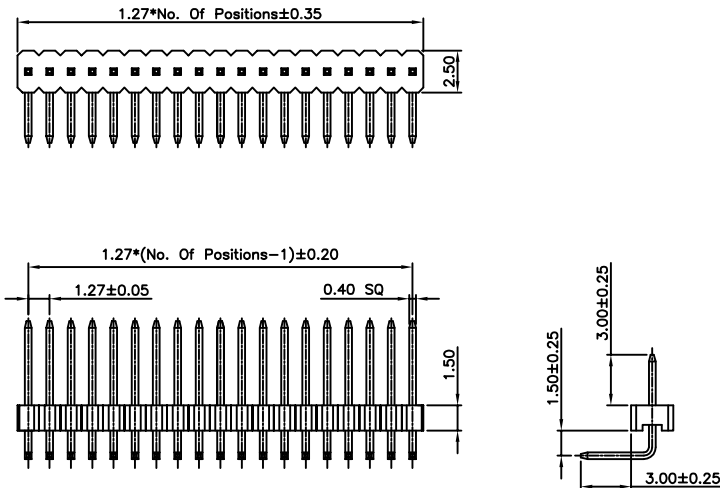

Specifications

Rating

Current Rating:1.0 Amp
Voltage Rating:100V AC/DC
Operating Temperature Range:-40°~+105°C

Electrical

Contact resistance:20m Ohm Max
Insulator resistance:500M ohm min.
Withstanding Voltage:500V AC/Minute

Material And Finish

Insulator:Nylon 6T UL94V-0 Color:Black
Contact:Brass
Plated:Gold Flash Over Nickel

No.of CKTS	Part No.	No.of CKTS	Part No.
01	0413102-010100	26	0413102-260100
02	0413102-020100	27	0413102-270100
03	0413102-030100	28	0413102-280100
04	0413102-040100	29	0413102-290100
05	0413102-050100	30	0413102-300100
06	0413102-060100	31	0413102-310100
07	0413102-070100	32	0413102-320100
08	0413102-080100	33	0413102-330100
09	0413102-090100	34	0413102-340100
10	0413102-100100	35	0413102-350100
11	0413102-110100	36	0413102-360100
12	0413102-120100	37	0413102-370100
13	0413102-130100	38	0413102-380100
14	0413102-140100	39	0413102-390100
15	0413102-150100	40	0413102-400100
16	0413102-160100	41	0413102-410100
17	0413102-170100	42	0413102-420100
18	0413102-180100	43	0413102-430100
19	0413102-190100	44	0413102-440100
20	0413102-200100	45	0413102-450100
21	0413102-210100	46	0413102-460100
22	0413102-220100	47	0413102-470100
23	0413102-230100	48	0413102-480100
24	0413102-240100	49	0413102-490100
25	0413102-250100	50	0413102-500100

1.27mm(0.05") Pitch
Pin Header Connector

04131022
Right Angle, Through Hole

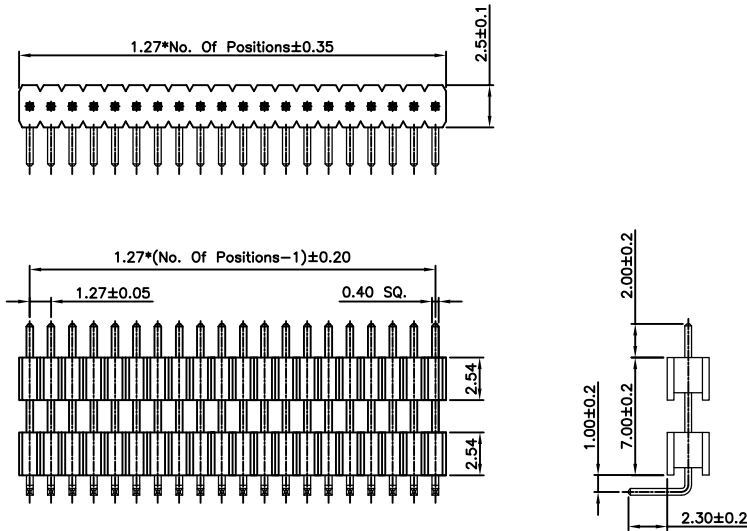

Specifications

Rating

Current Rating:1.0 Amp
Voltage Rating:100V AC/DC
Operating Temperature Range:-40°~+105°C

Electrical

Contact resistance:20m Ohm Max
Insulator resistance:500M ohm min.
Withstanding Voltage:500V AC/Minute

Material And Finish

Insulator:Nylon 6T UL94V-0 Color:Black
Contact:Brass
Plated:Gold Flash Over Nickel

No.of CKTS	Part No.	No.of CKTS	Part No.
01	04131022-010100	26	04131022-260100
02	04131022-020100	27	04131022-270100
03	04131022-030100	28	04131022-280100
04	04131022-040100	29	04131022-290100
05	04131022-050100	30	04131022-300100
06	04131022-060100	31	04131022-310100
07	04131022-070100	32	04131022-320100
08	04131022-080100	33	04131022-330100
09	04131022-090100	34	04131022-340100
10	04131022-100100	35	04131022-350100
11	04131022-110100	36	04131022-360100
12	04131022-120100	37	04131022-370100
13	04131022-130100	38	04131022-380100
14	04131022-140100	39	04131022-390100
15	04131022-150100	40	04131022-400100
16	04131022-160100	41	04131022-410100
17	04131022-170100	42	04131022-420100
18	04131022-180100	43	04131022-430100
19	04131022-190100	44	04131022-440100
20	04131022-200100	45	04131022-450100
21	04131022-210100	46	04131022-460100
22	04131022-220100	47	04131022-470100
23	04131022-230100	48	04131022-480100
24	04131022-240100	49	04131022-490100
25	04131022-250100	50	04131022-500100

1.27mm(0.05") Pitch
Pin Header Connector

0413111
Vertical, Through Hole

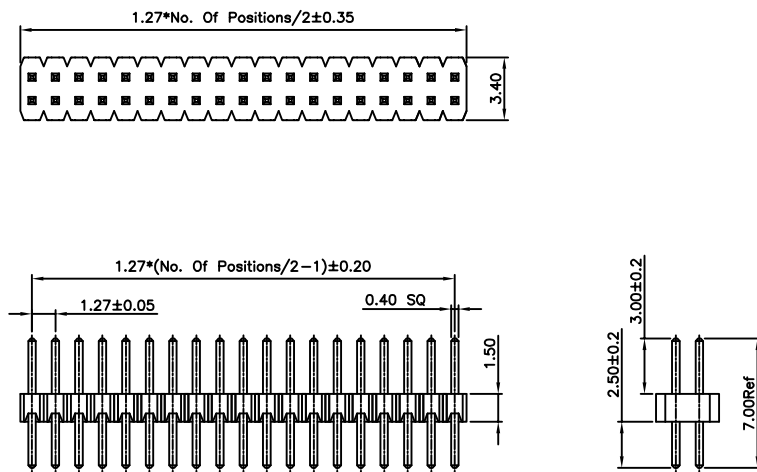

Specifications

Rating

Current Rating:1.0 Amp
Voltage Rating:100V AC/DC
Operating Temperature Range:-40°~+105°C

Electrical

Contact resistance:20m Ohm Max
Insulator resistance:500M ohm min.
Withstanding Voltage:500V AC/Minute

Material And Finish

Insulator:Nylon 6T UL94V-0 Color:Black
Contact:Brass
Plated:Gold Flash Over Nickel

No.of CKTS	Part No.	No.of CKTS	Part No.
04	0413111-040100	52	0413111-520100
06	0413111-060100	54	0413111-540100
08	0413111-080100	56	0413111-560100
10	0413111-100100	58	0413111-580100
12	0413111-120100	60	0413111-600100
14	0413111-140100	62	0413111-620100
16	0413111-160100	64	0413111-640100
18	0413111-180100	66	0413111-660100
20	0413111-200100	68	0413111-680100
22	0413111-220100	70	0413111-700100
24	0413111-240100	72	0413111-720100
26	0413111-260100	74	0413111-740100
28	0413111-280100	76	0413111-760100
30	0413111-300100	78	0413111-780100
32	0413111-320100	80	0413111-800100
34	0413111-340100	82	0413111-820100
36	0413111-360100	84	0413111-840100
38	0413111-380100	86	0413111-860100
40	0413111-400100	88	0413111-880100
42	0413111-420100	90	0413111-900100
44	0413111-440100	92	0413111-920100
46	0413111-460100	94	0413111-940100
48	0413111-480100	96	0413111-960100
50	0413111-500100	98	0413111-980100
		100	0413111-1000100

1.27mm(0.05") Pitch
Pin Header Connector

04131112
Vertical, Through Hole

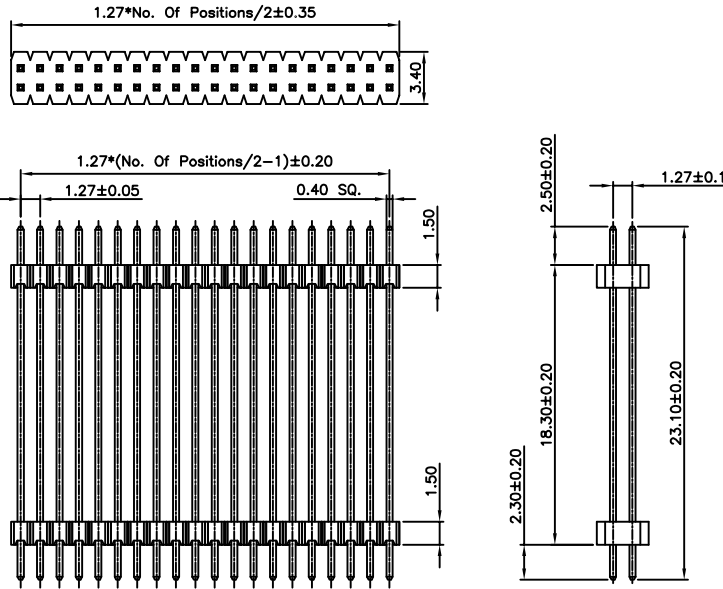

Specifications

Rating

Current Rating:1.0 Amp
Voltage Rating:100V AC/DC
Operating Temperature Range:-40°~+105°C

Electrical

Contact resistance:20m Ohm Max
Insulator resistance:500M ohm min.
Withstanding Voltage:500V AC/Minute

Material And Finish

Insulator:Nylon 6T UL94V-0 Color:Black
Contact:Brass
Plated:Gold Flash Over Nickel

No.of CKTS	Part No.	No.of CKTS	Part No.
04	04131112-040101	52	04131112-520101
06	04131112-060101	54	04131112-540101
08	04131112-080101	56	04131112-560101
10	04131112-100101	58	04131112-580101
12	04131112-120101	60	04131112-600101
14	04131112-140101	62	04131112-620101
16	04131112-160101	64	04131112-640101
18	04131112-180101	66	04131112-660101
20	04131112-200101	68	04131112-680101
22	04131112-220101	70	04131112-700101
24	04131112-240101	72	04131112-720101
26	04131112-260101	74	04131112-740101
28	04131112-280101	76	04131112-760101
30	04131112-300101	78	04131112-780101
32	04131112-320101	80	04131112-800101
34	04131112-340101	82	04131112-820101
36	04131112-360101	84	04131112-840101
38	04131112-380101	86	04131112-860101
40	04131112-400101	88	04131112-880101
42	04131112-420101	90	04131112-900101
44	04131112-440101	92	04131112-920101
46	04131112-460101	94	04131112-940101
48	04131112-480101	96	04131112-960101
50	04131112-500101	98	04131112-980101
		100	04131112-1000101

1.27mm(0.05") Pitch
Pin Header Connector

04131112
Right Angle, Through Hole

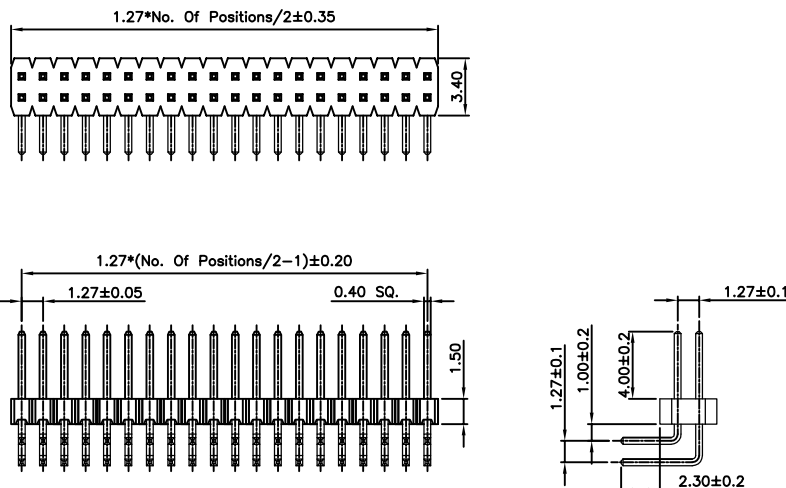

Specifications

Rating

Current Rating:1.0 Amp
Voltage Rating:100V AC/DC
Operating Temperature Range:-40°~+105°C

Electrical

Contact resistance:20m Ohm Max
Insulator resistance:500M ohm min.
Withstanding Voltage:500V AC/Minute

Material And Finish

Insulator:Nylon 6T UL94V-0 Color:Black
Contact:Brass
Plated:Gold Flash Over Nickel

No.of CKTS	Part No.	No.of CKTS	Part No.
04	04131112-040100	52	04131112-520100
06	04131112-060100	54	04131112-540100
08	04131112-080100	56	04131112-560100
10	04131112-100100	58	04131112-580100
12	04131112-120100	60	04131112-600100
14	04131112-140100	62	04131112-620100
16	04131112-160100	64	04131112-640100
18	04131112-180100	66	04131112-660100
20	04131112-200100	68	04131112-680100
22	04131112-220100	70	04131112-700100
24	04131112-240100	72	04131112-720100
26	04131112-260100	74	04131112-740100
28	04131112-280100	76	04131112-760100
30	04131112-300100	78	04131112-780100
32	04131112-320100	80	04131112-800100
34	04131112-340100	82	04131112-820100
36	04131112-360100	84	04131112-840100
38	04131112-380100	86	04131112-860100
40	04131112-400100	88	04131112-880100
42	04131112-420100	90	04131112-900100
44	04131112-440100	92	04131112-920100
46	04131112-460100	94	04131112-940100
48	04131112-480100	96	04131112-960100
50	04131112-500100	98	04131112-980100
		100	04131112-1000100

1.27mm(0.05") Pitch
Pin Header Connector

0413113
Vertical, SMT

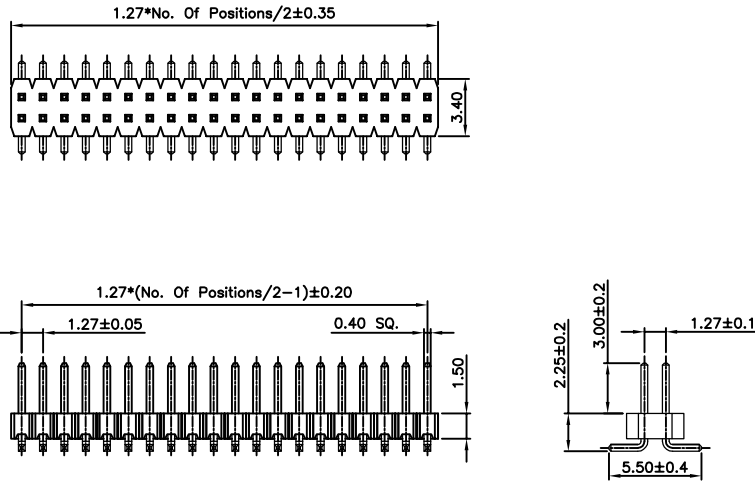

Specifications

Rating

Current Rating:1.0 Amp
Voltage Rating:100V AC/DC
Operating Temperature Range:-40°~+105°C

Electrical

Contact resistance:20m Ohm Max
Insulator resistance:500M ohm min.
Withstanding Voltage:500V AC/Minute

Material And Finish

Insulator:Nylon 6T UL94V-0 Color:Black
Contact:Brass
Plated:Gold Flash Over Nickel

No.of CKTS	Part No.	No.of CKTS	Part No.
04	0413113-040101	52	0413113-520101
06	0413113-060101	54	0413113-540101
08	0413113-080101	56	0413113-560101
10	0413113-100101	58	0413113-580101
12	0413113-120101	60	0413113-600101
14	0413113-140101	62	0413113-620101
16	0413113-160101	64	0413113-640101
18	0413113-180101	66	0413113-660101
20	0413113-200101	68	0413113-680101
22	0413113-220101	70	0413113-700101
24	0413113-240101	72	0413113-720101
26	0413113-260101	74	0413113-740101
28	0413113-280101	76	0413113-760101
30	0413113-300101	78	0413113-780101
32	0413113-320101	80	0413113-800101
34	0413113-340101	82	0413113-820101
36	0413113-360101	84	0413113-840101
38	0413113-380101	86	0413113-860101
40	0413113-400101	88	0413113-880101
42	0413113-420101	90	0413113-900101
44	0413113-440101	92	0413113-920101
46	0413113-460101	94	0413113-940101
48	0413113-480101	96	0413113-960101
50	0413113-500101	98	0413113-980101
		100	0413113-1000101

1.27mm(0.05") Pitch
Pin Header Connector

04131132
Vertical, SMT

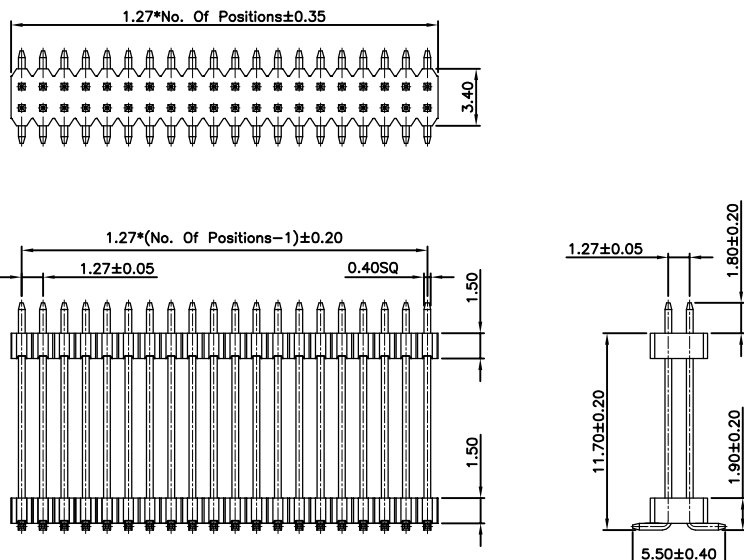

Specifications

Rating

Current Rating:1.0 Amp
Voltage Rating:100V AC/DC
Operating Temperature Range:-40°~+105°C

Electrical

Contact resistance:20m Ohm Max
Insulator resistance:500M ohm min.
Withstanding Voltage:500V AC/Minute

Material And Finish

Insulator:Nylon 6T UL94V-0 Color:Black
Contact:Brass
Plated:Gold Flash Over Nickel

No.of CKTS	Part No.	No.of CKTS	Part No.
04	04131132-040101	52	04131132-520101
06	04131132-060101	54	04131132-540101
08	04131132-080101	56	04131132-560101
10	04131132-100101	58	04131132-580101
12	04131132-120101	60	04131132-600101
14	04131132-140101	62	04131132-620101
16	04131132-160101	64	04131132-640101
18	04131132-180101	66	04131132-660101
20	04131132-200101	68	04131132-680101
22	04131132-220101	70	04131132-700101
24	04131132-240101	72	04131132-720101
26	04131132-260101	74	04131132-740101
28	04131132-280101	76	04131132-760101
30	04131132-300101	78	04131132-780101
32	04131132-320101	80	04131132-800101
34	04131132-340101	82	04131132-820101
36	04131132-360101	84	04131132-840101
38	04131132-380101	86	04131132-860101
40	04131132-400101	88	04131132-880101
42	04131132-420101	90	04131132-900101
44	04131132-440101	92	04131132-920101
46	04131132-460101	94	04131132-940101
48	04131132-480101	96	04131132-960101
50	04131132-500101	98	04131132-980101
		100	04131132-1000101

1.27mm(0.05") Pitch
Pin Header Connector

0413121
Vertical, Through Hole

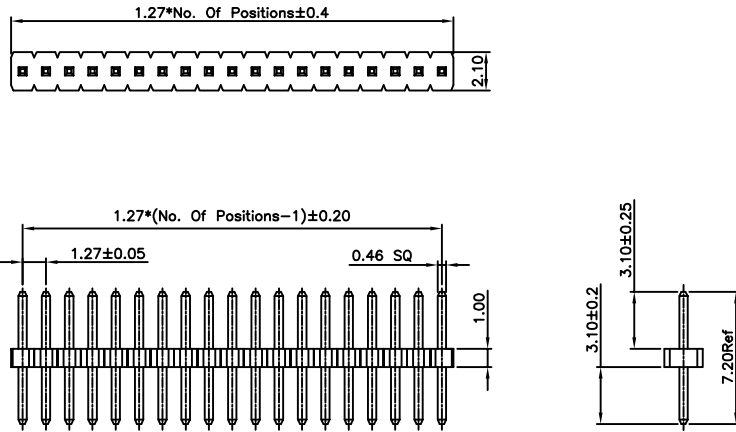

Specifications

Rating

Current Rating:1.0 Amp
Voltage Rating:100V AC/DC
Operating Temperature Range:-40°~+105°C

Electrical

Contact resistance:20m Ohm Max
Insulator resistance:500M ohm min.
Withstanding Voltage:500V AC/Minute

Material And Finish

Insulator:Nylon 6T UL94V-0 Color:Black
Contact:Brass
Plated:Gold Flash Over Nickel

No.of CKTS	Part No.	No.of CKTS	Part No.
01	0413121-010100	26	0413121-260100
02	0413121-020100	27	0413121-270100
03	0413121-030100	28	0413121-280100
04	0413121-040100	29	0413121-290100
05	0413121-050100	30	0413121-300100
06	0413121-060100	31	0413121-310100
07	0413121-070100	32	0413121-320100
08	0413121-080100	33	0413121-330100
09	0413121-090100	34	0413121-340100
10	0413121-100100	35	0413121-350100
11	0413121-110100	36	0413121-360100
12	0413121-120100	37	0413121-370100
13	0413121-130100	38	0413121-380100
14	0413121-140100	39	0413121-390100
15	0413121-150100	40	0413121-400100
16	0413121-160100	41	0413121-410100
17	0413121-170100	42	0413121-420100
18	0413121-180100	43	0413121-430100
19	0413121-190100	44	0413121-440100
20	0413121-200100	45	0413121-450100
21	0413121-210100	46	0413121-460100
22	0413121-220100	47	0413121-470100
23	0413121-230100	48	0413121-480100
24	0413121-240100	49	0413121-490100
25	0413121-250100	50	0413121-500100

1.27mm(0.05") Pitch
Pin Header Connector

04131212
Vertical, Through Hole

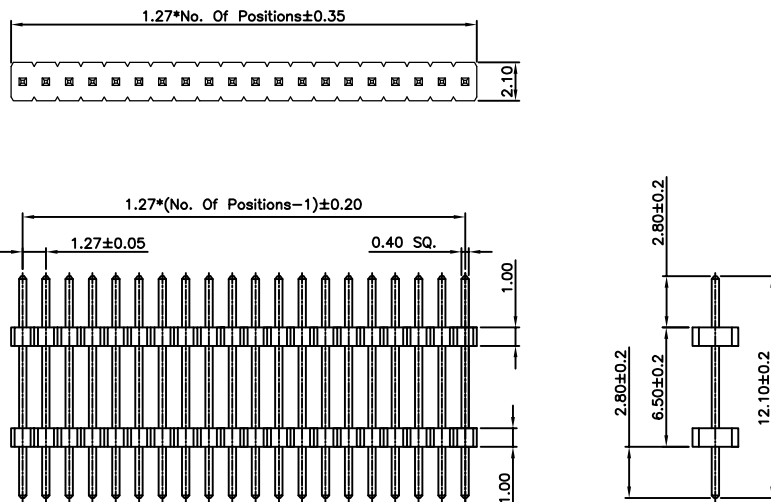

Specifications

Rating

Current Rating:1.0 Amp
Voltage Rating:100V AC/DC
Operating Temperature Range:-40°~+105°C

Electrical

Contact resistance:20m Ohm Max
Insulator resistance:500M ohm min.
Withstanding Voltage:500V AC/Minute

Material And Finish

Insulator:Nylon 6T UL94V-0 Color:Black
Contact:Brass
Plated:Gold Flash Over Nickel

No.of CKTS	Part No.	No.of CKTS	Part No.
01	04131212-010100	26	04131212-260100
02	04131212-020100	27	04131212-270100
03	04131212-030100	28	04131212-280100
04	04131212-040100	29	04131212-290100
05	04131212-050100	30	04131212-300100
06	04131212-060100	31	04131212-310100
07	04131212-070100	32	04131212-320100
08	04131212-080100	33	04131212-330100
09	04131212-090100	34	04131212-340100
10	04131212-100100	35	04131212-350100
11	04131212-110100	36	04131212-360100
12	04131212-120100	37	04131212-370100
13	04131212-130100	38	04131212-380100
14	04131212-140100	39	04131212-390100
15	04131212-150100	40	04131212-400100
16	04131212-160100	41	04131212-410100
17	04131212-170100	42	04131212-420100
18	04131212-180100	43	04131212-430100
19	04131212-190100	44	04131212-440100
20	04131212-200100	45	04131212-450100
21	04131212-210100	46	04131212-460100
22	04131212-220100	47	04131212-470100
23	04131212-230100	48	04131212-480100
24	04131212-240100	49	04131212-490100
25	04131212-250100	50	04131212-500100

1.27mm(0.05") Pitch
Pin Header Connector

0413122
Right Angle, Through Hole

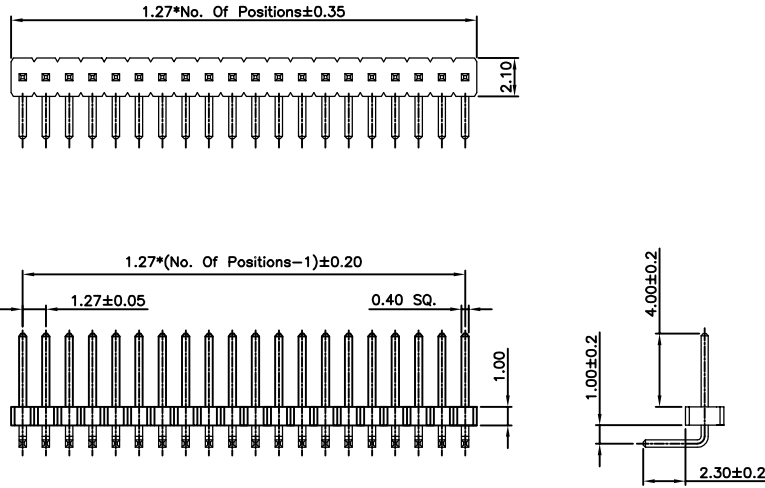

Specifications

Rating

Current Rating:1.0 Amp
Voltage Rating:100V AC/DC
Operating Temperature Range:-40°~+105°C

Electrical

Contact resistance:20m Ohm Max
Insulator resistance:500M ohm min.
Withstanding Voltage:500V AC/Minute

Material And Finish

Insulator:Nylon 6T UL94V-0 Color:Black
Contact:Brass
Plated:Gold Flash Over Nickel

No.of CKTS	Part No.	No.of CKTS	Part No.
01	0413122-010100	26	0413122-260100
02	0413122-020100	27	0413122-270100
03	0413122-030100	28	0413122-280100
04	0413122-040100	29	0413122-290100
05	0413122-050100	30	0413122-300100
06	0413122-060100	31	0413122-310100
07	0413122-070100	32	0413122-320100
08	0413122-080100	33	0413122-330100
09	0413122-090100	34	0413122-340100
10	0413122-100100	35	0413122-350100
11	0413122-110100	36	0413122-360100
12	0413122-120100	37	0413122-370100
13	0413122-130100	38	0413122-380100
14	0413122-140100	39	0413122-390100
15	0413122-150100	40	0413122-400100
16	0413122-160100	41	0413122-410100
17	0413122-170100	42	0413122-420100
18	0413122-180100	43	0413122-430100
19	0413122-190100	44	0413122-440100
20	0413122-200100	45	0413122-450100
21	0413122-210100	46	0413122-460100
22	0413122-220100	47	0413122-470100
23	0413122-230100	48	0413122-480100
24	0413122-240100	49	0413122-490100
25	0413122-250100	50	0413122-500100

1.27mm(0.05") Pitch
Pin Header Connector

04131222
Right Angle, Through Hole

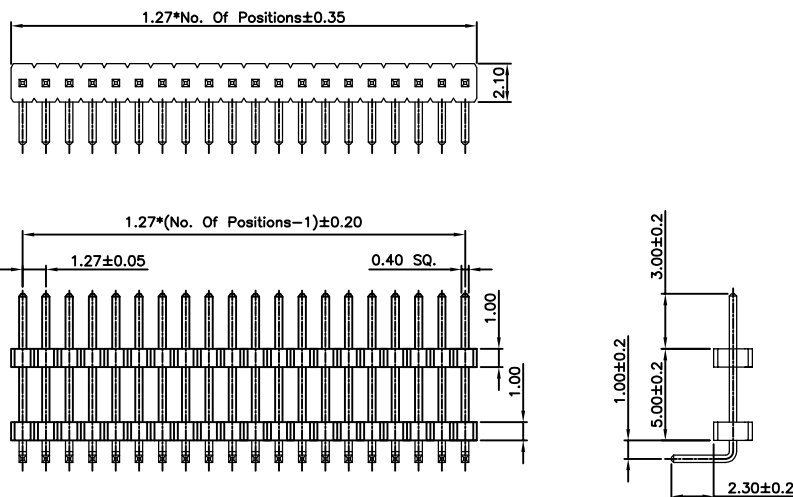

Specifications

Rating

Current Rating:1.0 Amp
Voltage Rating:100V AC/DC
Operating Temperature Range:-40°~+105°C

Electrical

Contact resistance:20m Ohm Max
Insulator resistance:500M ohm min.
Withstanding Voltage:500V AC/Minute

Material And Finish

Insulator:Nylon 6T UL94V-0 Color:Black
Contact:Brass
Plated:Gold Flash Over Nickel

No.of CKTS	Part No.	No.of CKTS	Part No.
01	04131222-010100	26	04131222-260100
02	04131222-020100	27	04131222-270100
03	04131222-030100	28	04131222-280100
04	04131222-040100	29	04131222-290100
05	04131222-050100	30	04131222-300100
06	04131222-060100	31	04131222-310100
07	04131222-070100	32	04131222-320100
08	04131222-080100	33	04131222-330100
09	04131222-090100	34	04131222-340100
10	04131222-100100	35	04131222-350100
11	04131222-110100	36	04131222-360100
12	04131222-120100	37	04131222-370100
13	04131222-130100	38	04131222-380100
14	04131222-140100	39	04131222-390100
15	04131222-150100	40	04131222-400100
16	04131222-160100	41	04131222-410100
17	04131222-170100	42	04131222-420100
18	04131222-180100	43	04131222-430100
19	04131222-190100	44	04131222-440100
20	04131222-200100	45	04131222-450100
21	04131222-210100	46	04131222-460100
22	04131222-220100	47	04131222-470100
23	04131222-230100	48	04131222-480100
24	04131222-240100	49	04131222-490100
25	04131222-250100	50	04131222-500100

1.27mm(0.05") Pitch
Pin Header Connector

0413123
Vertical, SMT

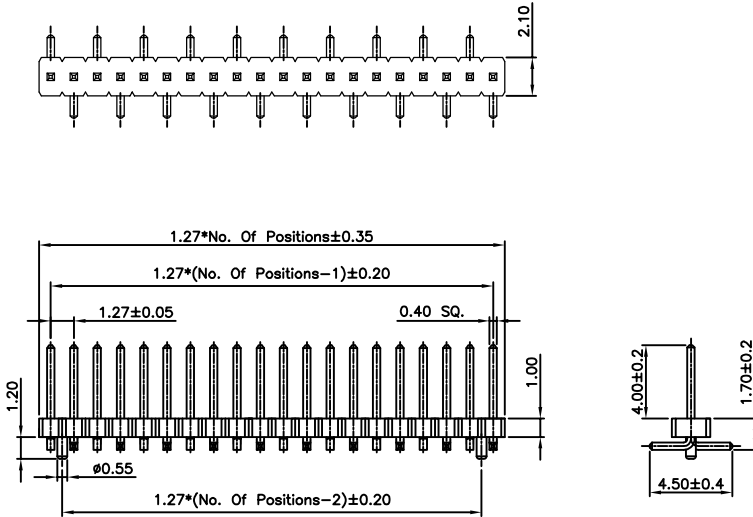

Specifications

Rating

Current Rating:1.0 Amp
Voltage Rating:100V AC/DC
Operating Temperature Range:-40°~+105°C

Electrical

Contact resistance:20m Ohm Max
Insulator resistance:500M ohm min.
Withstanding Voltage:500V AC/Minute

Material And Finish

Insulator:Nylon 6T UL94V-0 Color:Black
Contact:Brass
Plated:Gold Flash Over Nickel

No.of CKTS	Part No.	No.of CKTS	Part No.
02	0413123-020101	26	0413123-260101
03	0413123-030101	27	0413123-270101
04	0413123-040101	28	0413123-280101
05	0413123-050101	29	0413123-290101
06	0413123-060101	30	0413123-300101
07	0413123-070101	31	0413123-310101
08	0413123-080101	32	0413123-320101
09	0413123-090101	33	0413123-330101
10	0413123-100101	34	0413123-340101
11	0413123-110101	35	0413123-350101
12	0413123-120101	36	0413123-360101
13	0413123-130101	37	0413123-370101
14	0413123-140101	38	0413123-380101
15	0413123-150101	39	0413123-390101
16	0413123-160101	40	0413123-400101
17	0413123-170101	41	0413123-410101
18	0413123-180101	42	0413123-420101
19	0413123-190101	43	0413123-430101
20	0413123-200101	44	0413123-440101
21	0413123-210101	45	0413123-450101
22	0413123-220101	46	0413123-460101
23	0413123-230101	47	0413123-470101
24	0413123-240101	48	0413123-480101
25	0413123-250101	49	0413123-490101
		50	0413123-500101

1.27mm(0.05") Pitch
Pin Header Connector

04131232
Vertical, SMT

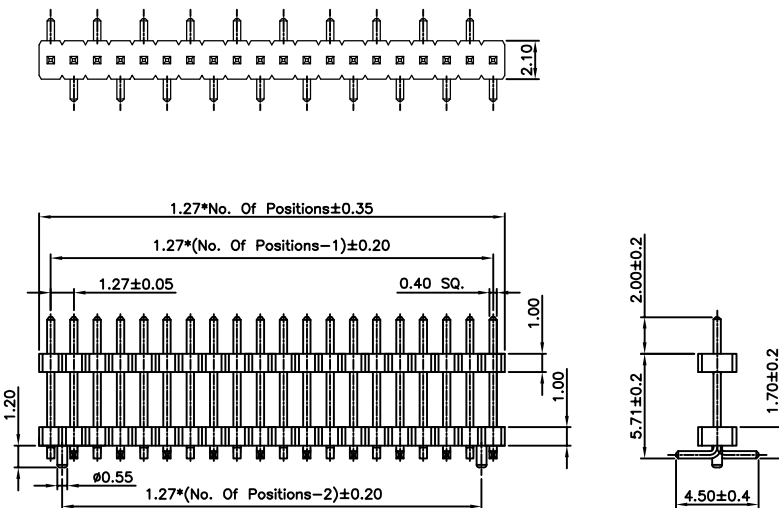

Specifications

Rating

Current Rating:1.0 Amp
Voltage Rating:100V AC/DC
Operating Temperature Range:-40°~+105°C

Electrical

Contact resistance:20m Ohm Max
Insulator resistance:500M ohm min.
Withstanding Voltage:500V AC/Minute

Material And Finish

Insulator:Nylon 6T UL94V-0 Color:Black
Contact:Brass
Plated:Gold Flash Over Nickel

No.of CKTS	Part No.	No.of CKTS	Part No.
02	04131232-020101	26	04131232-260101
03	04131232-030101	27	04131232-270101
04	04131232-040101	28	04131232-280101
05	04131232-050101	29	04131232-290101
06	04131232-060101	30	04131232-300101
07	04131232-070101	31	04131232-310101
08	04131232-080101	32	04131232-320101
09	04131232-090101	33	04131232-330101
10	04131232-100101	34	04131232-340101
11	04131232-110101	35	04131232-350101
12	04131232-120101	36	04131232-360101
13	04131232-130101	37	04131232-370101
14	04131232-140101	38	04131232-380101
15	04131232-150101	39	04131232-390101
16	04131232-160101	40	04131232-400101
17	04131232-170101	41	04131232-410101
18	04131232-180101	42	04131232-420101
19	04131232-190101	43	04131232-430101
20	04131232-200101	44	04131232-440101
21	04131232-210101	45	04131232-450101
22	04131232-220101	46	04131232-460101
23	04131232-230101	47	04131232-470101
24	04131232-240101	48	04131232-480101
25	04131232-250101	49	04131232-490101
		50	04131232-500101

1.27mm(0.05") Pitch
Pin Header Connector

0413131
Vertical, Through Hole

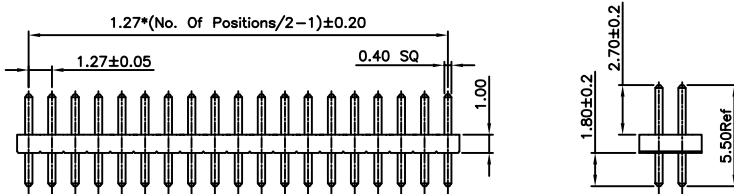
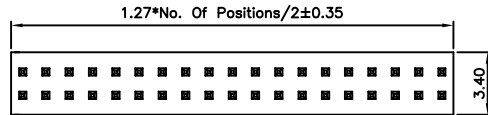

Specifications

Rating

Current Rating:1.0 Amp
Voltage Rating:100V AC/DC
Operating Temperature Range:-40°~+105°C

Electrical

Contact resistance:20m Ohm Max
Insulator resistance:500M ohm min.
Withstanding Voltage:500V AC/Minute

Material And Finish

Insulator:Nylon 6T UL94V-0 Color:Black
Contact:Brass
Plated:Gold Flash Over Nickel

No.of CKTS	Part No.	No.of CKTS	Part No.
04	0413131-040100	52	0413131-520100
06	0413131-060100	54	0413131-540100
08	0413131-080100	56	0413131-560100
10	0413131-100100	58	0413131-580100
12	0413131-120100	60	0413131-600100
14	0413131-140100	62	0413131-620100
16	0413131-160100	64	0413131-640100
18	0413131-180100	66	0413131-660100
20	0413131-200100	68	0413131-680100
22	0413131-220100	70	0413131-700100
24	0413131-240100	72	0413131-720100
26	0413131-260100	74	0413131-740100
28	0413131-280100	76	0413131-760100
30	0413131-300100	78	0413131-780100
32	0413131-320100	80	0413131-800100
34	0413131-340100	82	0413131-820100
36	0413131-360100	84	0413131-840100
38	0413131-380100	86	0413131-860100
40	0413131-400100	88	0413131-880100
42	0413131-420100	90	0413131-900100
44	0413131-440100	92	0413131-920100
46	0413131-460100	94	0413131-940100
48	0413131-480100	96	0413131-960100
50	0413131-500100	98	0413131-980100
		100	0413131-1000100

1.27mm(0.05") Pitch
Pin Header Connector

0413141
Vertical, Through Hole

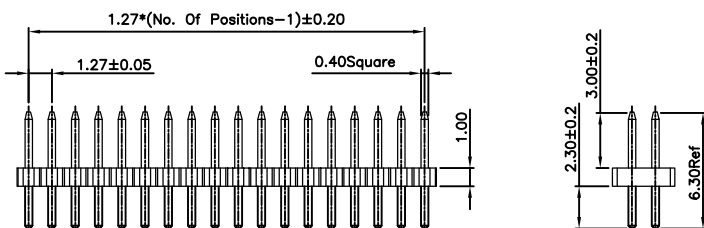
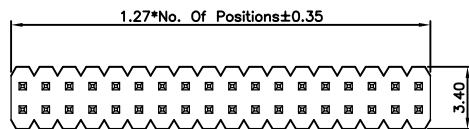

Specifications

Rating

Current Rating:1.0 Amp
Voltage Rating:100V AC/DC
Operating Temperature Range:-40°~+105°C

Electrical

Contact resistance:20m Ohm Max
Insulator resistance:500M ohm min.
Withstanding Voltage:500V AC/Minute

Material And Finish

Insulator:Nylon 6T UL94V-0 Color:Black
Contact:Brass
Plated:Gold Flash Over Nickel

No.of CKTS	Part No.	No.of CKTS	Part No.
04	0413141-040100	52	0413141-520100
06	0413141-060100	54	0413141-540100
08	0413141-080100	56	0413141-560100
10	0413141-100100	58	0413141-580100
12	0413141-120100	60	0413141-600100
14	0413141-140100	62	0413141-620100
16	0413141-160100	64	0413141-640100
18	0413141-180100	66	0413141-660100
20	0413141-200100	68	0413141-680100
22	0413141-220100	70	0413141-700100
24	0413141-240100	72	0413141-720100
26	0413141-260100	74	0413141-740100
28	0413141-280100	76	0413141-760100
30	0413141-300100	78	0413141-780100
32	0413141-320100	80	0413141-800100
34	0413141-340100	82	0413141-820100
36	0413141-360100	84	0413141-840100
38	0413141-380100	86	0413141-860100
40	0413141-400100	88	0413141-880100
42	0413141-420100	90	0413141-900100
44	0413141-440100	92	0413141-920100
46	0413141-460100	94	0413141-940100
48	0413141-480100	96	0413141-960100
50	0413141-500100	98	0413141-980100
		100	0413141-1000100

1.27mm(0.05") Pitch
Pin Header Connector

0413142
Right Angle, Through Hole

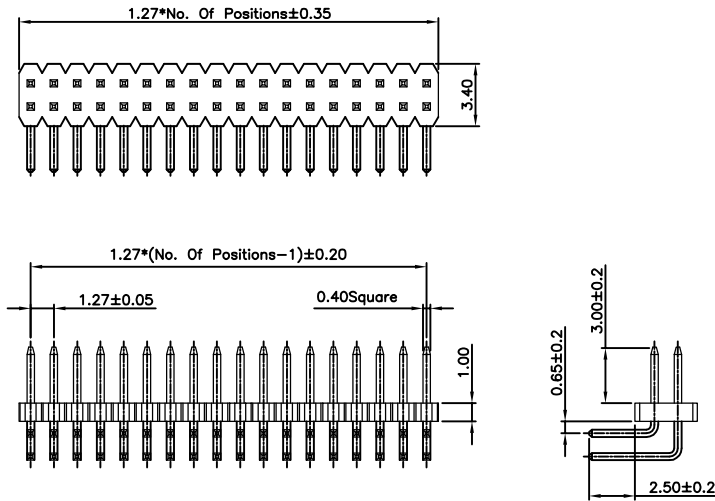

Specifications

Rating

Current Rating:1.0 Amp
Voltage Rating:100V AC/DC
Operating Temperature Range:-40°~+105°C

Electrical

Contact resistance:20m Ohm Max
Insulator resistance:500M ohm min.
Withstanding Voltage:500V AC/Minute

Material And Finish

Insulator:Nylon 6T UL94V-0 Color:Black
Contact:Brass
Plated:Gold Flash Over Nickel

No.of CKTS	Part No.	No.of CKTS	Part No.
04	0413142-040100	52	0413142-520100
06	0413142-060100	54	0413142-540100
08	0413142-080100	56	0413142-560100
10	0413142-100100	58	0413142-580100
12	0413142-120100	60	0413142-600100
14	0413142-140100	62	0413142-620100
16	0413142-160100	64	0413142-640100
18	0413142-180100	66	0413142-660100
20	0413142-200100	68	0413142-680100
22	0413142-220100	70	0413142-700100
24	0413142-240100	72	0413142-720100
26	0413142-260100	74	0413142-740100
28	0413142-280100	76	0413142-760100
30	0413142-300100	78	0413142-780100
32	0413142-320100	80	0413142-800100
34	0413142-340100	82	0413142-820100
36	0413142-360100	84	0413142-840100
38	0413142-380100	86	0413142-860100
40	0413142-400100	88	0413142-880100
42	0413142-420100	90	0413142-900100
44	0413142-440100	92	0413142-920100
46	0413142-460100	94	0413142-940100
48	0413142-480100	96	0413142-960100
50	0413142-500100	98	0413142-980100
		100	0413142-1000100

1.27mm(0.05") Pitch
Pin Header Connector

0413143
Vertical, SMT

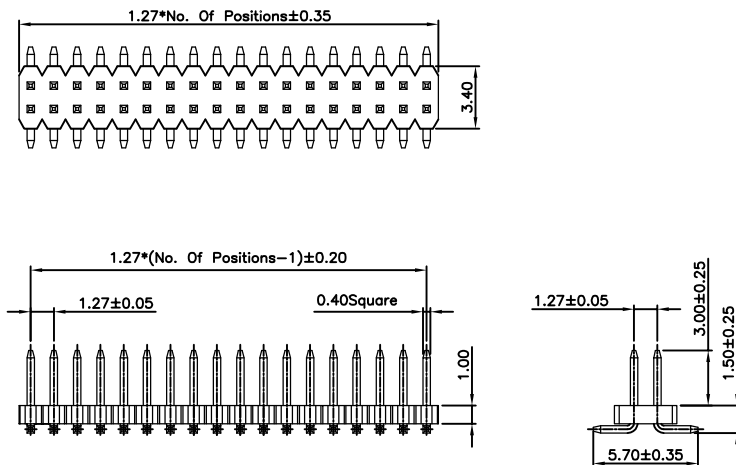

Specifications

Rating

Current Rating:1.0 Amp
Voltage Rating:100V AC/DC
Operating Temperature Range:-40°~+105°C

Electrical

Contact resistance:20m Ohm Max
Insulator resistance:500M ohm min.
Withstanding Voltage:500V AC/Minute

Material And Finish

Insulator:Nylon 6T UL94V-0 Color:Black
Contact:Brass
Plated:Gold Flash Over Nickel

No.of CKTS	Part No.	No.of CKTS	Part No.
04	0413143-040101	52	0413143-520101
06	0413143-060101	54	0413143-540101
08	0413143-080101	56	0413143-560101
10	0413143-100101	58	0413143-580101
12	0413143-120101	60	0413143-600101
14	0413143-140101	62	0413143-620101
16	0413143-160101	64	0413143-640101
18	0413143-180101	66	0413143-660101
20	0413143-200101	68	0413143-680101
22	0413143-220101	70	0413143-700101
24	0413143-240101	72	0413143-720101
26	0413143-260101	74	0413143-740101
28	0413143-280101	76	0413143-760101
30	0413143-300101	78	0413143-780101
32	0413143-320101	80	0413143-800101
34	0413143-340101	82	0413143-820101
36	0413143-360101	84	0413143-840101
38	0413143-380101	86	0413143-860101
40	0413143-400101	88	0413143-880101
42	0413143-420101	90	0413143-900101
44	0413143-440101	92	0413143-920101
46	0413143-460101	94	0413143-940101
48	0413143-480101	96	0413143-960101
50	0413143-500101	98	0413143-980101
		100	0413143-1000101

1.27mm(0.05") Pitch
Pin Header Connector

0413151
Vertical, Through Hole

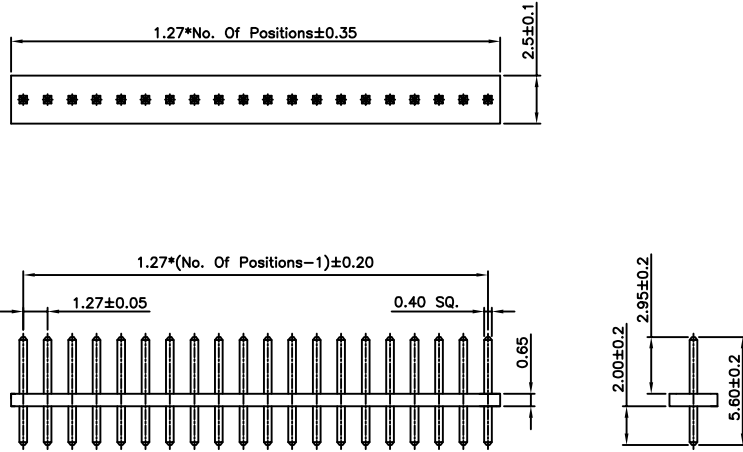

Specifications

Rating

Current Rating:1.0 Amp
Voltage Rating:100V AC/DC
Operating Temperature Range:-40°~+105°C

Electrical

Contact resistance:20m Ohm Max
Insulator resistance:500M ohm min.
Withstanding Voltage:500V AC/Minute

Material And Finish

Insulator:Nylon 6T UL94V-0 Color:Black
Contact:Brass
Plated:Gold Flash Over Nickel

No.of CKTS	Part No.	No.of CKTS	Part No.
01	0413151-010100	26	0413151-260100
02	0413151-020100	27	0413151-270100
03	0413151-030100	28	0413151-280100
04	0413151-040100	29	0413151-290100
05	0413151-050100	30	0413151-300100
06	0413151-060100	31	0413151-310100
07	0413151-070100	32	0413151-320100
08	0413151-080100	33	0413151-330100
09	0413151-090100	34	0413151-340100
10	0413151-100100	35	0413151-350100
11	0413151-110100	36	0413151-360100
12	0413151-120100	37	0413151-370100
13	0413151-130100	38	0413151-380100
14	0413151-140100	39	0413151-390100
15	0413151-150100	40	0413151-400100
16	0413151-160100	41	0413151-410100
17	0413151-170100	42	0413151-420100
18	0413151-180100	43	0413151-430100
19	0413151-190100	44	0413151-440100
20	0413151-200100	45	0413151-450100
21	0413151-210100	46	0413151-460100
22	0413151-220100	47	0413151-470100
23	0413151-230100	48	0413151-480100
24	0413151-240100	49	0413151-490100
25	0413151-250100	50	0413151-500100

1.27mm(0.05") Pitch
Pin Header Connector

0413152
Right Angle, Through Hole

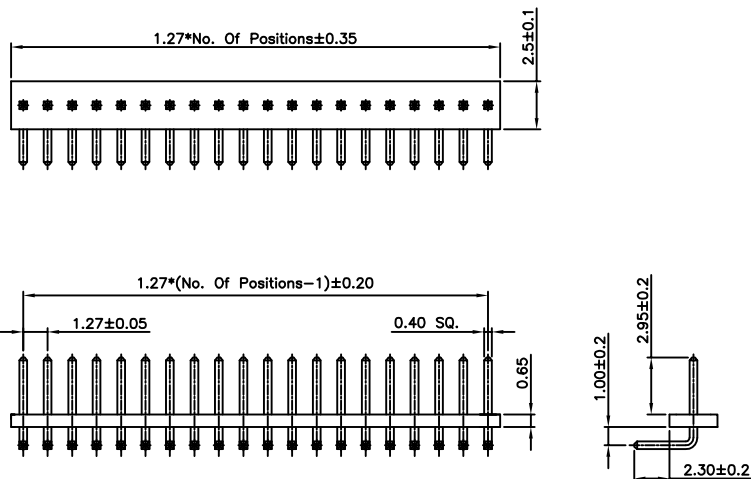

Specifications

Rating

Current Rating:1.0 Amp
Voltage Rating:100V AC/DC
Operating Temperature Range:-40°~+105°C

Electrical

Contact resistance:20m Ohm Max
Insulator resistance:500M ohm min.
Withstanding Voltage:500V AC/Minute

Material And Finish

Insulator:Nylon 6T UL94V-0 Color:Black
Contact:Brass
Plated:Gold Flash Over Nickel

No.of CKTS	Part No.	No.of CKTS	Part No.
01	0413152-010100	26	0413152-260100
02	0413152-020100	27	0413152-270100
03	0413152-030100	28	0413152-280100
04	0413152-040100	29	0413152-290100
05	0413152-050100	30	0413152-300100
06	0413152-060100	31	0413152-310100
07	0413152-070100	32	0413152-320100
08	0413152-080100	33	0413152-330100
09	0413152-090100	34	0413152-340100
10	0413152-100100	35	0413152-350100
11	0413152-110100	36	0413152-360100
12	0413152-120100	37	0413152-370100
13	0413152-130100	38	0413152-380100
14	0413152-140100	39	0413152-390100
15	0413152-150100	40	0413152-400100
16	0413152-160100	41	0413152-410100
17	0413152-170100	42	0413152-420100
18	0413152-180100	43	0413152-430100
19	0413152-190100	44	0413152-440100
20	0413152-200100	45	0413152-450100
21	0413152-210100	46	0413152-460100
22	0413152-220100	47	0413152-470100
23	0413152-230100	48	0413152-480100
24	0413152-240100	49	0413152-490100
25	0413152-250100	50	0413152-500100

2.00mm(0.079") Pitch
Pin Header Connector

0420011

Vertical, Through Hole

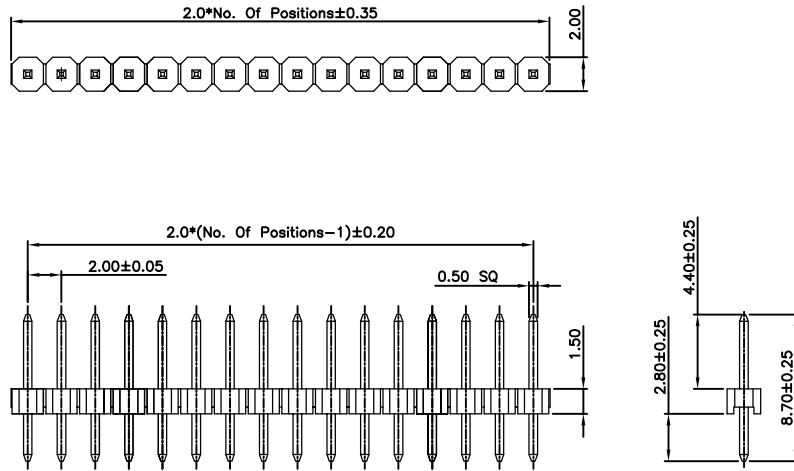

Specifications

Rating

Current Rating:2.0 Amp
Voltage Rating:150V AC/DC
Operating Temperature Range:-40°~+105°C

Electrical

Contact resistance:20m Ohm Max
Insulator resistance:1000M ohm min.
Withstanding Voltage:500V AC/Minute

Material And Finish

Insulator:Nylon 6T UL94V-0 Color:Black
Contact:Brass
Plated:Gold Flash Over Nickel

No.of CKTS	Part No.	No.of CKTS	Part No.
01	0420011-010100	21	0420011-210100
02	0420011-020100	22	0420011-220100
03	0420011-030100	23	0420011-230100
04	0420011-040100	24	0420011-240100
05	0420011-050100	25	0420011-250100
06	0420011-060100	26	0420011-260100
07	0420011-070100	27	0420011-270100
08	0420011-080100	28	0420011-280100
09	0420011-090100	29	0420011-290100
10	0420011-100100	30	0420011-300100
11	0420011-110100	31	0420011-310100
12	0420011-120100	32	0420011-320100
13	0420011-130100	33	0420011-330100
14	0420011-140100	34	0420011-340100
15	0420011-150100	35	0420011-350100
16	0420011-160100	36	0420011-360100
17	0420011-170100	37	0420011-370100
18	0420011-180100	38	0420011-380100
19	0420011-190100	39	0420011-390100
20	0420011-200100	40	0420011-400100

2.00mm(0.079") Pitch
Pin Header Connector

0420012

Vertical, Through Hole

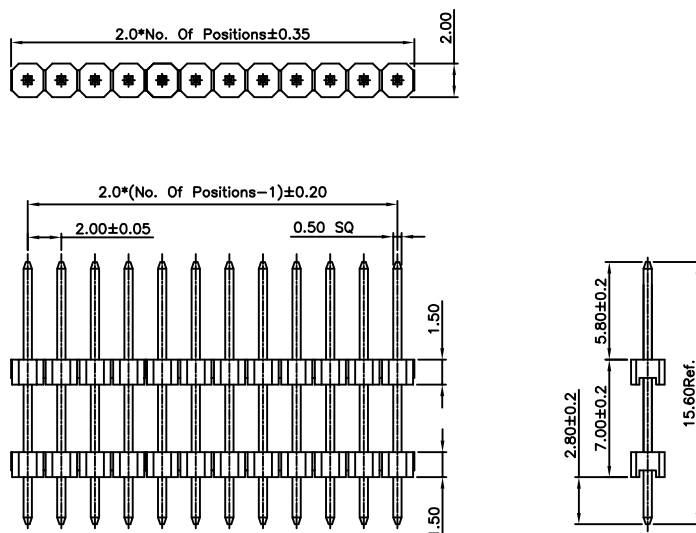

Specifications

Rating

Current Rating:2.0 Amp
Voltage Rating:150V AC/DC
Operating Temperature Range:-40°~+105°C

Electrical

Contact resistance:20m Ohm Max
Insulator resistance:1000M ohm min.
Withstanding Voltage:500V AC/Minute

Material And Finish

Insulator:Nylon 6T UL94V-0 Color:Black
Contact:Brass
Plated:Gold Flash Over Nickel

No.of CKTS	Part No.	No.of CKTS	Part No.
01	0420012-010100	21	0420012-210100
02	0420012-020100	22	0420012-220100
03	0420012-030100	23	0420012-230100
04	0420012-040100	24	0420012-240100
05	0420012-050100	25	0420012-250100
06	0420012-060100	26	0420012-260100
07	0420012-070100	27	0420012-270100
08	0420012-080100	28	0420012-280100
09	0420012-090100	29	0420012-290100
10	0420012-100100	30	0420012-300100
11	0420012-110100	31	0420012-310100
12	0420012-120100	32	0420012-320100
13	0420012-130100	33	0420012-330100
14	0420012-140100	34	0420012-340100
15	0420012-150100	35	0420012-350100
16	0420012-160100	36	0420012-360100
17	0420012-170100	37	0420012-370100
18	0420012-180100	38	0420012-380100
19	0420012-190100	39	0420012-390100
20	0420012-200100	40	0420012-400100

2.00mm(0.079") Pitch
Pin Header Connector

0420012
Right Angle, Through Hole

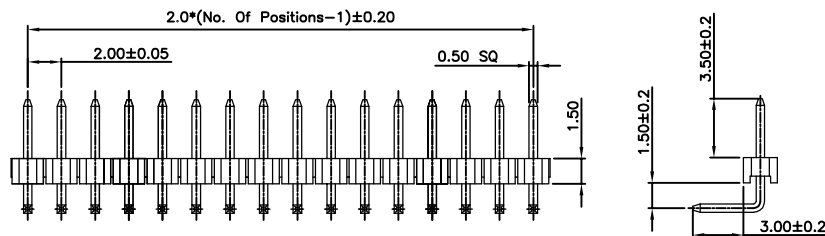
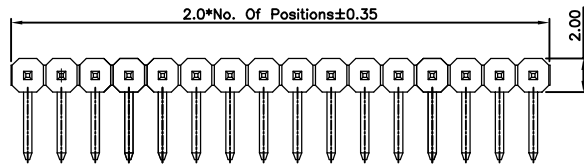

Specifications

Rating

Current Rating:2.0 Amp
Voltage Rating:150V AC/DC
Operating Temperature Range:-40°~+105°C

Electrical

Contact resistance:20m Ohm Max
Insulator resistance:1000M ohm min.
Withstanding Voltage:500V AC/Minute

Material And Finish

Insulator:Nylon 6T UL94V-0 Color:Black
Contact:Brass
Plated:Gold Flash Over Nickel

No.of CKTS	Part No.	No.of CKTS	Part No.
01	0420012-010100	21	0420012-210100
02	0420012-020100	22	0420012-220100
03	0420012-030100	23	0420012-230100
04	0420012-040100	24	0420012-240100
05	0420012-050100	25	0420012-250100
06	0420012-060100	26	0420012-260100
07	0420012-070100	27	0420012-270100
08	0420012-080100	28	0420012-280100
09	0420012-090100	29	0420012-290100
10	0420012-100100	30	0420012-300100
11	0420012-110100	31	0420012-310100
12	0420012-120100	32	0420012-320100
13	0420012-130100	33	0420012-330100
14	0420012-140100	34	0420012-340100
15	0420012-150100	35	0420012-350100
16	0420012-160100	36	0420012-360100
17	0420012-170100	37	0420012-370100
18	0420012-180100	38	0420012-380100
19	0420012-190100	39	0420012-390100
20	0420012-200100	40	0420012-400100

2.00mm(0.079") Pitch
Pin Header Connector

04200122
Right Angle, Through Hole

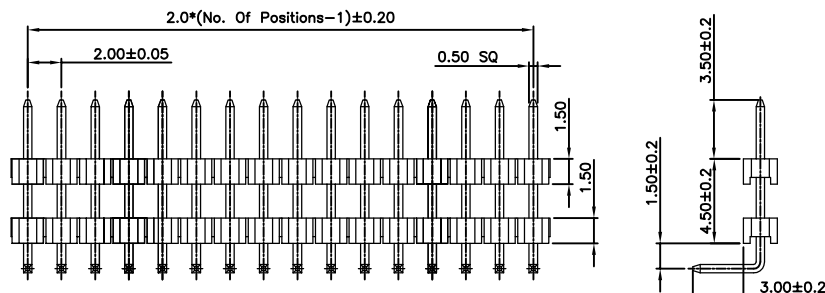
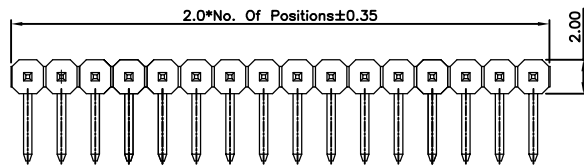

Specifications

Rating

Current Rating:2.0 Amp
Voltage Rating:150V AC/DC
Operating Temperature Range:-40°~+105°C

Electrical

Contact resistance:20m Ohm Max
Insulator resistance:1000M ohm min.
Withstanding Voltage:500V AC/Minute

Material And Finish

Insulator:Nylon 6T UL94V-0 Color:Black
Contact:Brass
Plated:Gold Flash Over Nickel

No.of CKTS	Part No.	No.of CKTS	Part No.
01	04200122-010100	21	04200122-210100
02	04200122-020100	22	04200122-220100
03	04200122-030100	23	04200122-230100
04	04200122-040100	24	04200122-240100
05	04200122-050100	25	04200122-250100
06	04200122-060100	26	04200122-260100
07	04200122-070100	27	04200122-270100
08	04200122-080100	28	04200122-280100
09	04200122-090100	29	04200122-290100
10	04200122-100100	30	04200122-300100
11	04200122-110100	31	04200122-310100
12	04200122-120100	32	04200122-320100
13	04200122-130100	33	04200122-330100
14	04200122-140100	34	04200122-340100
15	04200122-150100	35	04200122-350100
16	04200122-160100	36	04200122-360100
17	04200122-170100	37	04200122-370100
18	04200122-180100	38	04200122-380100
19	04200122-190100	39	04200122-390100
20	04200122-200100	40	04200122-400100

2.00mm(0.079") Pitch
Pin Header Connector

0420013
Vertical, SMT

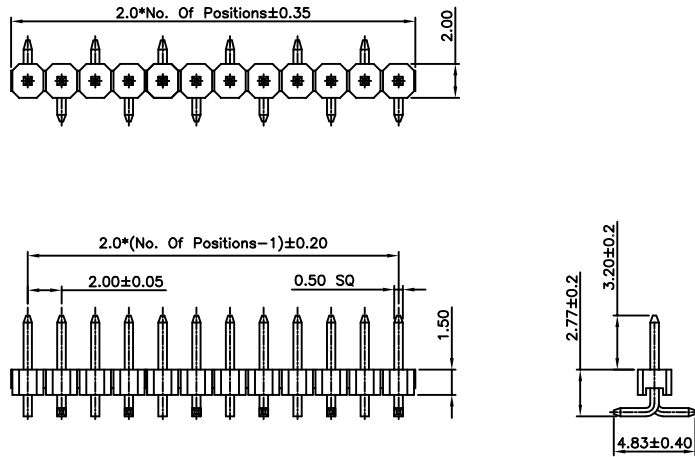

Specifications

Rating

Current Rating:2.0 Amp
Voltage Rating:150V AC/DC
Operating Temperature Range:-40°~+105°C

Electrical

Contact resistance:20m Ohm Max
Insulator resistance:1000M ohm min.
Withstanding Voltage:500V AC/Minute

Material And Finish

Insulator:Nylon 6T UL94V-0 Color:Black
Contact:Brass
Plated:Gold Flash Over Nickel

No.of CKTS	Part No.	No.of CKTS	Part No.
02	0420013-020101	21	0420013-210101
03	0420013-030101	22	0420013-220101
04	0420013-040101	23	0420013-230101
05	0420013-050101	24	0420013-240101
06	0420013-060101	25	0420013-250101
07	0420013-070101	26	0420013-260101
08	0420013-080101	27	0420013-270101
09	0420013-090101	28	0420013-280101
10	0420013-100101	29	0420013-290101
11	0420013-110101	30	0420013-300101
12	0420013-120101	31	0420013-310101
13	0420013-130101	32	0420013-320101
14	0420013-140101	33	0420013-330101
15	0420013-150101	34	0420013-340101
16	0420013-160101	35	0420013-350101
17	0420013-170101	36	0420013-360101
18	0420013-180101	37	0420013-370101
19	0420013-190101	38	0420013-380101
20	0420013-200101	39	0420013-390101
		40	0420013-400101

2.00mm(0.079") Pitch
Pin Header Connector

04200132
Vertical, SMT

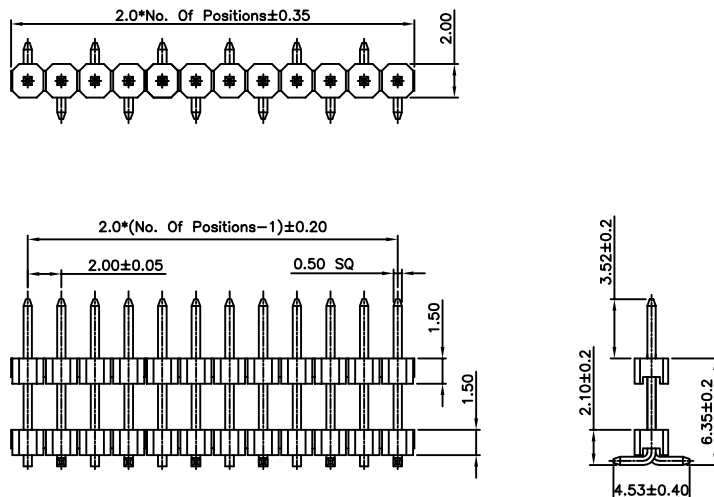

Specifications

Rating

Current Rating:2.0 Amp
Voltage Rating:150V AC/DC
Operating Temperature Range:-40°~+105°C

Electrical

Contact resistance:20m Ohm Max
Insulator resistance:1000M ohm min.
Withstanding Voltage:500V AC/Minute

Material And Finish

Insulator:Nylon 6T UL94V-0 Color:Black
Contact:Brass
Plated:Gold Flash Over Nickel

No.of CKTS	Part No.	No.of CKTS	Part No.
02	04200132-020101	21	04200132-210101
03	04200132-030101	22	04200132-220101
04	04200132-040101	23	04200132-230101
05	04200132-050101	24	04200132-240101
06	04200132-060101	25	04200132-250101
07	04200132-070101	26	04200132-260101
08	04200132-080101	27	04200132-270101
09	04200132-090101	28	04200132-280101
10	04200132-100101	29	04200132-290101
11	04200132-110101	30	04200132-300101
12	04200132-120101	31	04200132-310101
13	04200132-130101	32	04200132-320101
14	04200132-140101	33	04200132-330101
15	04200132-150101	34	04200132-340101
16	04200132-160101	35	04200132-350101
17	04200132-170101	36	04200132-360101
18	04200132-180101	37	04200132-370101
19	04200132-190101	38	04200132-380101
20	04200132-200101	39	04200132-390101
		40	04200132-400101

2.00mm(0.079") Pitch
Pin Header Connector

0420021

Vertical, Through Hole

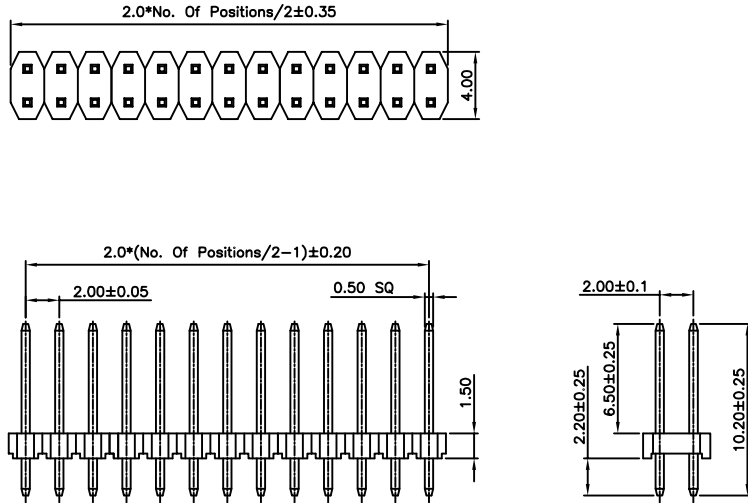

Specifications

Rating

Current Rating:2.0 Amp
Voltage Rating:150V AC/DC
Operating Temperature Range:-40°~+105°C

Electrical

Contact resistance:20m Ohm Max
Insulator resistance:1000M ohm min.
Withstanding Voltage:500V AC/Minute

Material And Finish

Insulator:Nylon 6T UL94V-0 Color:Black
Contact:Brass
Plated:Gold Flash Over Nickel

No.of CKTS	Part No.	No.of CKTS	Part No.
04	0420021-040100	42	0420021-420100
06	0420021-060100	44	0420021-440100
08	0420021-080100	46	0420021-460100
10	0420021-100100	48	0420021-480100
12	0420021-120100	50	0420021-500100
14	0420021-140100	52	0420021-520100
16	0420021-160100	54	0420021-540100
18	0420021-180100	56	0420021-560100
20	0420021-200100	58	0420021-580100
22	0420021-220100	60	0420021-600100
24	0420021-240100	62	0420021-620100
26	0420021-260100	64	0420021-640100
28	0420021-280100	66	0420021-660100
30	0420021-300100	68	0420021-680100
32	0420021-320100	70	0420021-700100
34	0420021-340100	72	0420021-720100
36	0420021-360100	74	0420021-740100
38	0420021-380100	76	0420021-760100
40	0420021-400100	78	0420021-780100
		80	0420021-800100

2.00mm(0.079") Pitch
Pin Header Connector

0420022

Right Angle, Through Hole

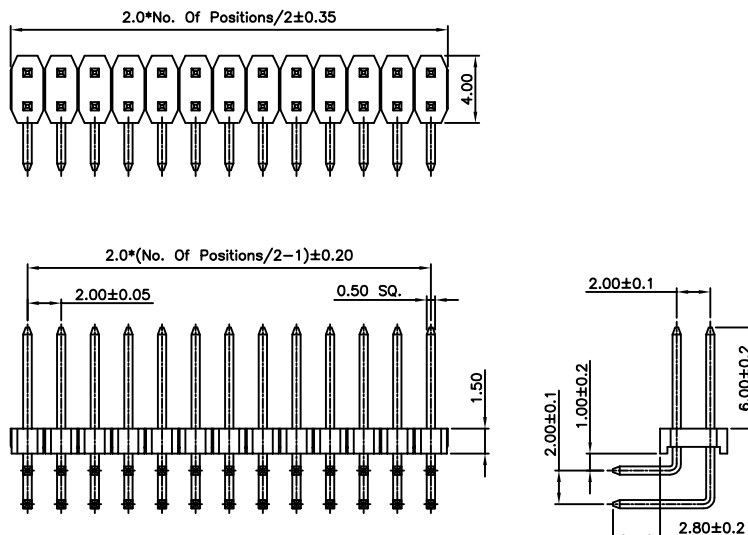

Specifications

Rating

Current Rating:2.0 Amp
Voltage Rating:150V AC/DC
Operating Temperature Range:-40°~+105°C

Electrical

Contact resistance:20m Ohm Max
Insulator resistance:1000M ohm min.
Withstanding Voltage:500V AC/Minute

Material And Finish

Insulator:Nylon 6T UL94V-0 Color:Black
Contact:Brass
Plated:Gold Flash Over Nickel

No.of CKTS	Part No.	No.of CKTS	Part No.
04	0420022-040100	42	0420022-420100
06	0420022-060100	44	0420022-440100
08	0420022-080100	46	0420022-460100
10	0420022-100100	48	0420022-480100
12	0420022-120100	50	0420022-500100
14	0420022-140100	52	0420022-520100
16	0420022-160100	54	0420022-540100
18	0420022-180100	56	0420022-560100
20	0420022-200100	58	0420022-580100
22	0420022-220100	60	0420022-600100
24	0420022-240100	62	0420022-620100
26	0420022-260100	64	0420022-640100
28	0420022-280100	66	0420022-660100
30	0420022-300100	68	0420022-680100
32	0420022-320100	70	0420022-700100
34	0420022-340100	72	0420022-720100
36	0420022-360100	74	0420022-740100
38	0420022-380100	76	0420022-760100
40	0420022-400100	78	0420022-780100
		80	0420022-800100

2.00mm(0.079") Pitch
Pin Header Connector

0420023

Vertical, SMT

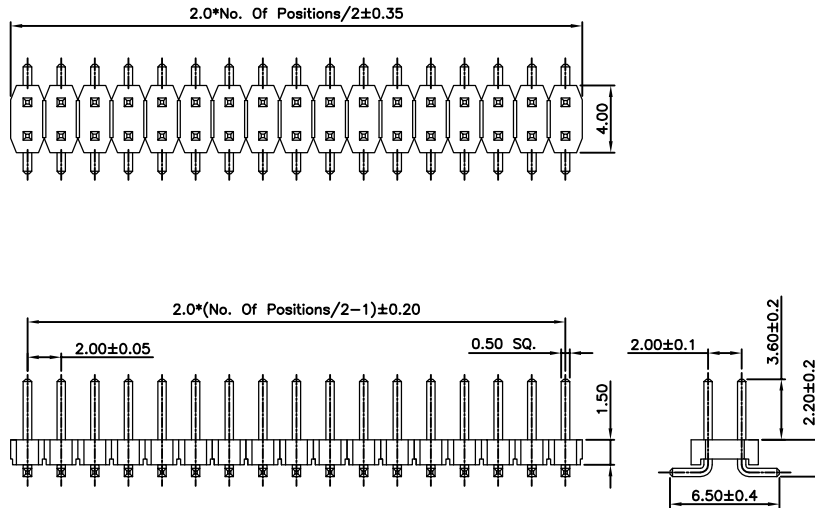

Specifications

Rating

Current Rating:2.0 Amp
Voltage Rating:150V AC/DC
Operating Temperature Range:-40°~+105°C

Electrical

Contact resistance:20m Ohm Max
Insulator resistance:1000M ohm min.
Withstanding Voltage:500V AC/Minute

Material And Finish

Insulator:Nylon 6T UL94V-0 Color:Black
Contact:Brass
Plated:Gold Flash Over Nickel

No.of CKTS	Part No.	No.of CKTS	Part No.
04	0420023-040101	42	0420023-420101
06	0420023-060101	44	0420023-440101
08	0420023-080101	46	0420023-460101
10	0420023-100101	48	0420023-480101
12	0420023-120101	50	0420023-500101
14	0420023-140101	52	0420023-520101
16	0420023-160101	54	0420023-540101
18	0420023-180101	56	0420023-560101
20	0420023-200101	58	0420023-580101
22	0420023-220101	60	0420023-600101
24	0420023-240101	62	0420023-620101
26	0420023-260101	64	0420023-640101
28	0420023-280101	66	0420023-660101
30	0420023-300101	68	0420023-680101
32	0420023-320101	70	0420023-700101
34	0420023-340101	72	0420023-720101
36	0420023-360101	74	0420023-740101
38	0420023-380101	76	0420023-760101
40	0420023-400101	78	0420023-780101
		80	0420023-800101

2.00mm(0.079") Pitch
Pin Header Connector

0420025

Right Angle, SMT

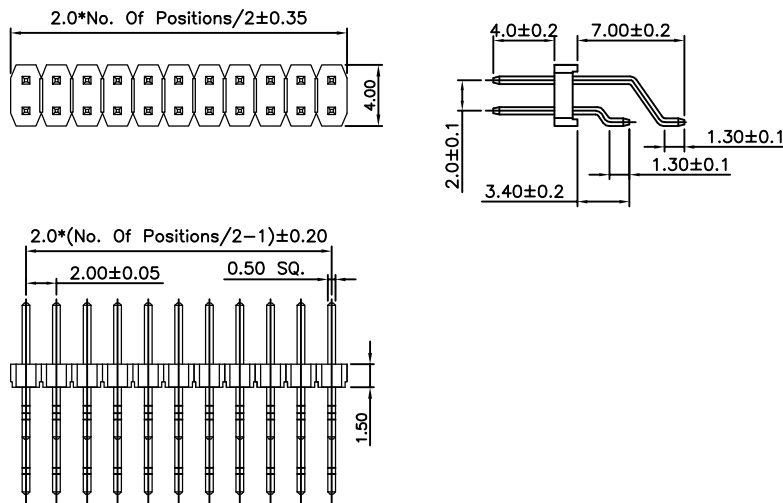

Specifications

Rating

Current Rating:2.0 Amp
Voltage Rating:150V AC/DC
Operating Temperature Range:-40°~+105°C

Electrical

Contact resistance:20m Ohm Max
Insulator resistance:1000M ohm min.
Withstanding Voltage:500V AC/Minute

Material And Finish

Insulator:Nylon 6T UL94V-0 Color:Black
Contact:Brass
Plated:Gold Flash Over Nickel

No.of CKTS	Part No.	No.of CKTS	Part No.
04	0420025-040101	42	0420025-420101
06	0420025-060101	44	0420025-440101
08	0420025-080101	46	0420025-460101
10	0420025-100101	48	0420025-480101
12	0420025-120101	50	0420025-500101
14	0420025-140101	52	0420025-520101
16	0420025-160101	54	0420025-540101
18	0420025-180101	56	0420025-560101
20	0420025-200101	58	0420025-580101
22	0420025-220101	60	0420025-600101
24	0420025-240101	62	0420025-620101
26	0420025-260101	64	0420025-640101
28	0420025-280101	66	0420025-660101
30	0420025-300101	68	0420025-680101
32	0420025-320101	70	0420025-700101
34	0420025-340101	72	0420025-720101
36	0420025-360101	74	0420025-740101
38	0420025-380101	76	0420025-760101
40	0420025-400101	78	0420025-780101
		80	0420025-800101

2.00mm(0.079") Pitch
Pin Header Connector

0420031

Vertical, Through Hole

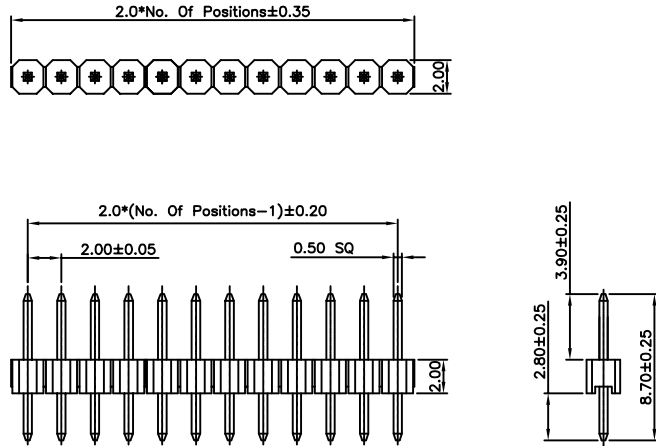

Specifications

Rating

Current Rating:2.0 Amp
Voltage Rating:150V AC/DC
Operating Temperature Range:-40°~+105°C

Electrical

Contact resistance:20m Ohm Max
Insulator resistance:1000M ohm min.
Withstanding Voltage:500V AC/Minute

Material And Finish

Insulator:Nylon 6T UL94V-0 Color:Black
Contact:Brass
Plated:Gold Flash Over Nickel

No.of CKTS	Part No.	No.of CKTS	Part No.
01	0420031-010100	21	0420031-210100
02	0420031-020100	22	0420031-220100
03	0420031-030100	23	0420031-230100
04	0420031-040100	24	0420031-240100
05	0420031-050100	25	0420031-250100
06	0420031-060100	26	0420031-260100
07	0420031-070100	27	0420031-270100
08	0420031-080100	28	0420031-280100
09	0420031-090100	29	0420031-290100
10	0420031-100100	30	0420031-300100
11	0420031-110100	31	0420031-310100
12	0420031-120100	32	0420031-320100
13	0420031-130100	33	0420031-330100
14	0420031-140100	34	0420031-340100
15	0420031-150100	35	0420031-350100
16	0420031-160100	36	0420031-360100
17	0420031-170100	37	0420031-370100
18	0420031-180100	38	0420031-380100
19	0420031-190100	39	0420031-390100
20	0420031-200100	40	0420031-400100

2.00mm(0.079") Pitch
Pin Header Connector

04200312

Vertical, Through Hole

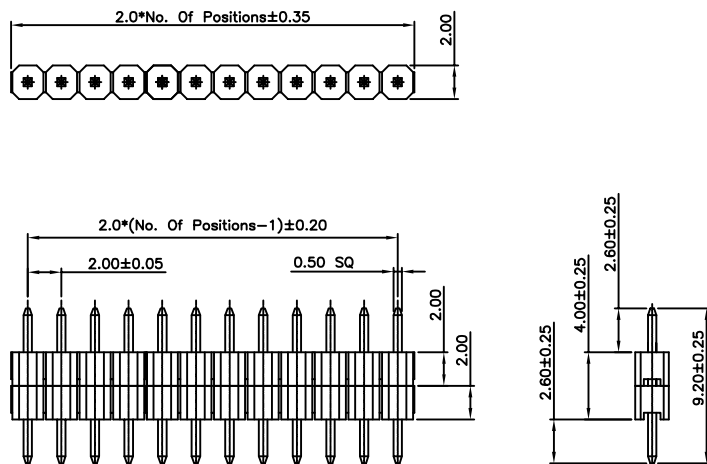

Specifications

Rating

Current Rating:2.0 Amp
Voltage Rating:150V AC/DC
Operating Temperature Range:-40°~+105°C

Electrical

Contact resistance:20m Ohm Max
Insulator resistance:1000M ohm min.
Withstanding Voltage:500V AC/Minute

Material And Finish

Insulator:Nylon 6T UL94V-0 Color:Black
Contact:Brass
Plated:Gold Flash Over Nickel

No.of CKTS	Part No.	No.of CKTS	Part No.
01	04200312-010100	21	04200312-210100
02	04200312-020100	22	04200312-220100
03	04200312-030100	23	04200312-230100
04	04200312-040100	24	04200312-240100
05	04200312-050100	25	04200312-250100
06	04200312-060100	26	04200312-260100
07	04200312-070100	27	04200312-270100
08	04200312-080100	28	04200312-280100
09	04200312-090100	29	04200312-290100
10	04200312-100100	30	04200312-300100
11	04200312-110100	31	04200312-310100
12	04200312-120100	32	04200312-320100
13	04200312-130100	33	04200312-330100
14	04200312-140100	34	04200312-340100
15	04200312-150100	35	04200312-350100
16	04200312-160100	36	04200312-360100
17	04200312-170100	37	04200312-370100
18	04200312-180100	38	04200312-380100
19	04200312-190100	39	04200312-390100
20	04200312-200100	40	04200312-400100

2.00mm(0.079") Pitch
Pin Header Connector

0420032

Right Angle, Through Hole

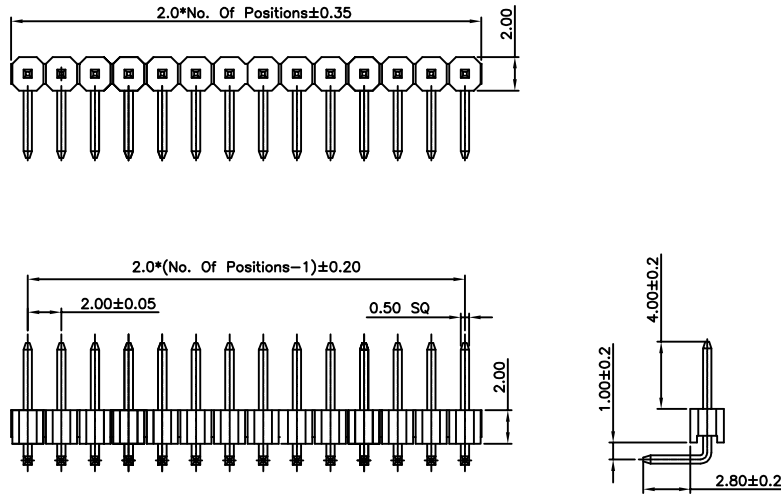

Specifications

Rating

Current Rating:2.0 Amp
Voltage Rating:150V AC/DC
Operating Temperature Range:-40°~+105°C

Electrical

Contact resistance:20m Ohm Max
Insulator resistance:1000M ohm min.
Withstanding Voltage:500V AC/Minute

Material And Finish

Insulator:Nylon 6T UL94V-0 Color:Black
Contact:Brass
Plated:Gold Flash Over Nickel

No.of CKTS	Part No.	No.of CKTS	Part No.
01	0420032-010100	21	0420032-210100
02	0420032-020100	22	0420032-220100
03	0420032-030100	23	0420032-230100
04	0420032-040100	24	0420032-240100
05	0420032-050100	25	0420032-250100
06	0420032-060100	26	0420032-260100
07	0420032-070100	27	0420032-270100
08	0420032-080100	28	0420032-280100
09	0420032-090100	29	0420032-290100
10	0420032-100100	30	0420032-300100
11	0420032-110100	31	0420032-310100
12	0420032-120100	32	0420032-320100
13	0420032-130100	33	0420032-330100
14	0420032-140100	34	0420032-340100
15	0420032-150100	35	0420032-350100
16	0420032-160100	36	0420032-360100
17	0420032-170100	37	0420032-370100
18	0420032-180100	38	0420032-380100
19	0420032-190100	39	0420032-390100
20	0420032-200100	40	0420032-400100

2.00mm(0.079") Pitch
Pin Header Connector

04200322

Right Angle, Through Hole

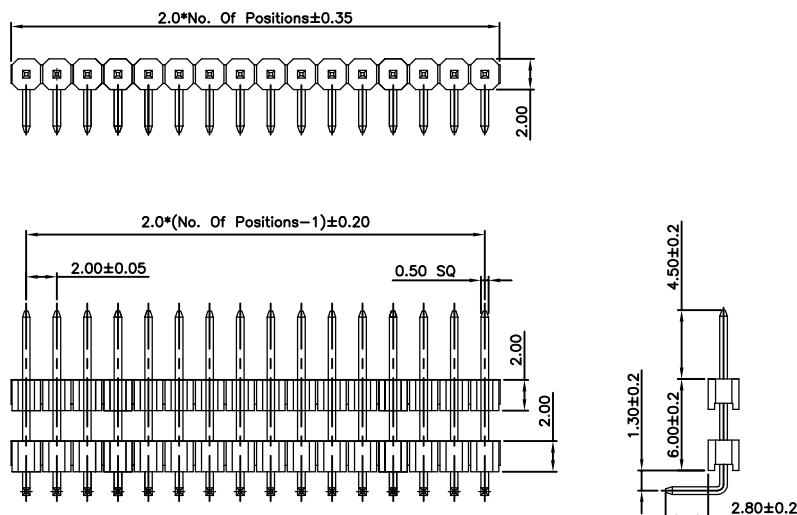

Specifications

Rating

Current Rating:2.0 Amp
Voltage Rating:150V AC/DC
Operating Temperature Range:-40°~+105°C

Electrical

Contact resistance:20m Ohm Max
Insulator resistance:1000M ohm min.
Withstanding Voltage:500V AC/Minute

Material And Finish

Insulator:Nylon 6T UL94V-0 Color:Black
Contact:Brass
Plated:Gold Flash Over Nickel

No.of CKTS	Part No.	No.of CKTS	Part No.
01	04200322-010100	21	04200322-210100
02	04200322-020100	22	04200322-220100
03	04200322-030100	23	04200322-230100
04	04200322-040100	24	04200322-240100
05	04200322-050100	25	04200322-250100
06	04200322-060100	26	04200322-260100
07	04200322-070100	27	04200322-270100
08	04200322-080100	28	04200322-280100
09	04200322-090100	29	04200322-290100
10	04200322-100100	30	04200322-300100
11	04200322-110100	31	04200322-310100
12	04200322-120100	32	04200322-320100
13	04200322-130100	33	04200322-330100
14	04200322-140100	34	04200322-340100
15	04200322-150100	35	04200322-350100
16	04200322-160100	36	04200322-360100
17	04200322-170100	37	04200322-370100
18	04200322-180100	38	04200322-380100
19	04200322-190100	39	04200322-390100
20	04200322-200100	40	04200322-400100

2.00mm(0.079") Pitch
Pin Header Connector

0420033

Vertical, SMT

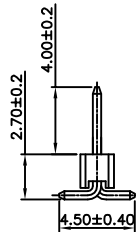
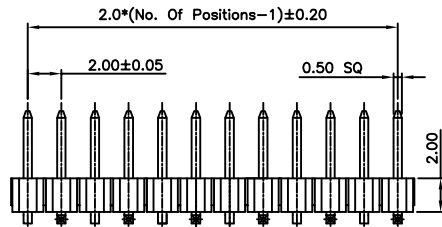
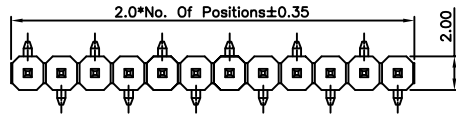

Specifications

Rating

Current Rating:2.0 Amp
Voltage Rating:150V AC/DC
Operating Temperature Range:-40°~+105°C

Electrical

Contact resistance:20m Ohm Max
Insulator resistance:1000M ohm min.
Withstanding Voltage:500V AC/Minute

Material And Finish

Insulator:Nylon 6T UL94V-0 Color:Black
Contact:Brass
Plated:Gold Flash Over Nickel

No.of CKTS	Part No.	No.of CKTS	Part No.
02	0420033-020101	21	0420033-210101
03	0420033-030101	22	0420033-220101
04	0420033-040101	23	0420033-230101
05	0420033-050101	24	0420033-240101
06	0420033-060101	25	0420033-250101
07	0420033-070101	26	0420033-260101
08	0420033-080101	27	0420033-270101
09	0420033-090101	28	0420033-280101
10	0420033-100101	29	0420033-290101
11	0420033-110101	30	0420033-300101
12	0420033-120101	31	0420033-310101
13	0420033-130101	32	0420033-320101
14	0420033-140101	33	0420033-330101
15	0420033-150101	34	0420033-340101
16	0420033-160101	35	0420033-350101
17	0420033-170101	36	0420033-360101
18	0420033-180101	37	0420033-370101
19	0420033-190101	38	0420033-380101
20	0420033-200101	39	0420033-390101
		40	0420033-400101

2.00mm(0.079") Pitch
Pin Header Connector

0420034

Vertical, SMT

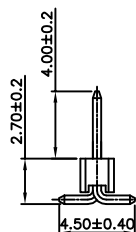
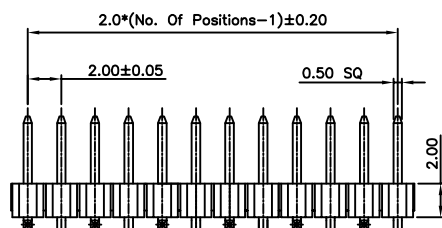
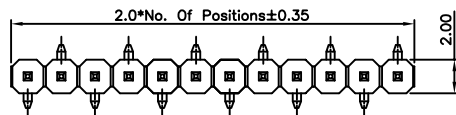

Specifications

Rating

Current Rating:2.0 Amp
Voltage Rating:150V AC/DC
Operating Temperature Range:-40°~+105°C

Electrical

Contact resistance:20m Ohm Max
Insulator resistance:1000M ohm min.
Withstanding Voltage:500V AC/Minute

Material And Finish

Insulator:Nylon 6T UL94V-0 Color:Black
Contact:Brass
Plated:Gold Flash Over Nickel

No.of CKTS	Part No.	No.of CKTS	Part No.
02	0420034-020101	21	0420034-210101
03	0420034-030101	22	0420034-220101
04	0420034-040101	23	0420034-230101
05	0420034-050101	24	0420034-240101
06	0420034-060101	25	0420034-250101
07	0420034-070101	26	0420034-260101
08	0420034-080101	27	0420034-270101
09	0420034-090101	28	0420034-280101
10	0420034-100101	29	0420034-290101
11	0420034-110101	30	0420034-300101
12	0420034-120101	31	0420034-310101
13	0420034-130101	32	0420034-320101
14	0420034-140101	33	0420034-330101
15	0420034-150101	34	0420034-340101
16	0420034-160101	35	0420034-350101
17	0420034-170101	36	0420034-360101
18	0420034-180101	37	0420034-370101
19	0420034-190101	38	0420034-380101
20	0420034-200101	39	0420034-390101
		40	0420034-400101

2.00mm(0.079") Pitch
Pin Header Connector

04200332
Vertical, SMT

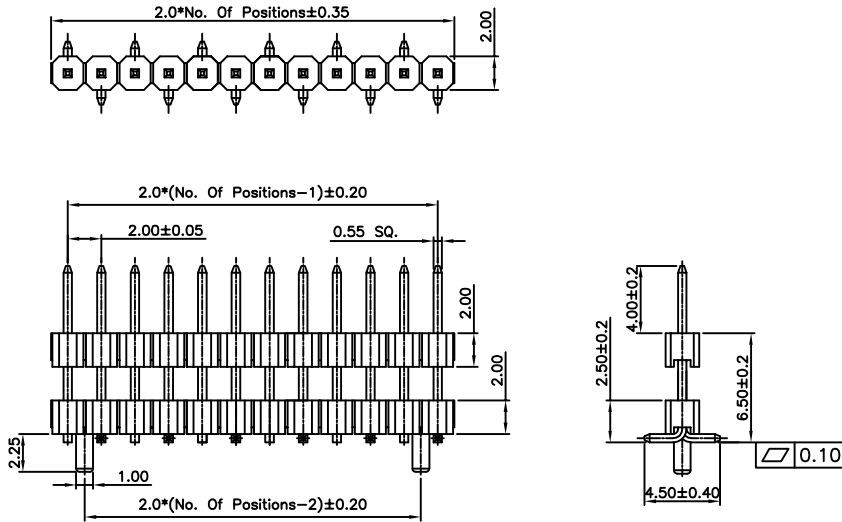

Specifications

Rating

Current Rating:2.0 Amp
Voltage Rating:150V AC/DC
Operating Temperature Range:-40°~+105°C

Electrical

Contact resistance:20m Ohm Max
Insulator resistance:1000M ohm min.
Withstanding Voltage:500V AC/Minute

Material And Finish

Insulator:Nylon 6T UL94V-0 Color:Black
Contact:Brass
Plated:Gold Flash Over Nickel

No.of CKTS	Part No.	No.of CKTS	Part No.
02	04200332-020101	21	04200332-210101
03	04200332-030101	22	04200332-220101
04	04200332-040101	23	04200332-230101
05	04200332-050101	24	04200332-240101
06	04200332-060101	25	04200332-250101
07	04200332-070101	26	04200332-260101
08	04200332-080101	27	04200332-270101
09	04200332-090101	28	04200332-280101
10	04200332-100101	29	04200332-290101
11	04200332-110101	30	04200332-300101
12	04200332-120101	31	04200332-310101
13	04200332-130101	32	04200332-320101
14	04200332-140101	33	04200332-330101
15	04200332-150101	34	04200332-340101
16	04200332-160101	35	04200332-350101
17	04200332-170101	36	04200332-360101
18	04200332-180101	37	04200332-370101
19	04200332-190101	38	04200332-380101
20	04200332-200101	39	04200332-390101
		40	04200332-400101

2.00mm(0.079") Pitch
Pin Header Connector

0420035
Right Angle, SMT

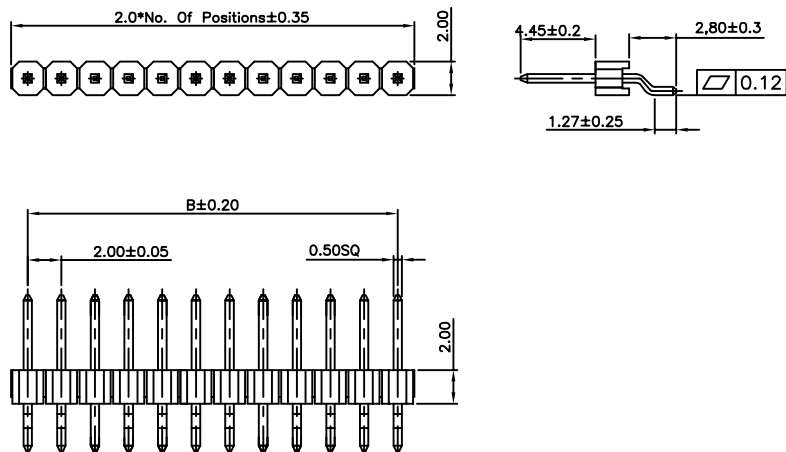

Specifications

Rating

Current Rating:2.0 Amp
Voltage Rating:150V AC/DC
Operating Temperature Range:-40°~+105°C

Electrical

Contact resistance:20m Ohm Max
Insulator resistance:1000M ohm min.
Withstanding Voltage:500V AC/Minute

Material And Finish

Insulator:Nylon 6T UL94V-0 Color:Black
Contact:Brass
Plated:Gold Flash Over Nickel

No.of CKTS	Part No.	No.of CKTS	Part No.
02	0420035-020101	21	0420035-210101
03	0420035-030101	22	0420035-220101
04	0420035-040101	23	0420035-230101
05	0420035-050101	24	0420035-240101
06	0420035-060101	25	0420035-250101
07	0420035-070101	26	0420035-260101
08	0420035-080101	27	0420035-270101
09	0420035-090101	28	0420035-280101
10	0420035-100101	29	0420035-290101
11	0420035-110101	30	0420035-300101
12	0420035-120101	31	0420035-310101
13	0420035-130101	32	0420035-320101
14	0420035-140101	33	0420035-330101
15	0420035-150101	34	0420035-340101
16	0420035-160101	35	0420035-350101
17	0420035-170101	36	0420035-360101
18	0420035-180101	37	0420035-370101
19	0420035-190101	38	0420035-380101
20	0420035-200101	39	0420035-390101
		40	0420035-400101

2.00mm(0.079") Pitch
Pin Header Connector

0420041

Vertical, Through Hole

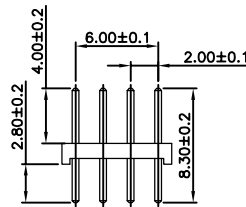
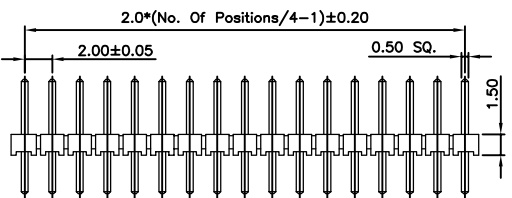
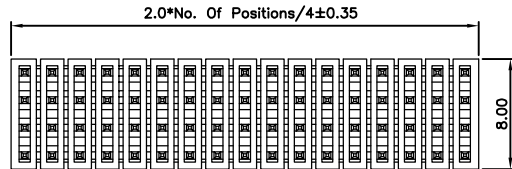

Specifications

Rating

Current Rating:2.0 Amp

Voltage Rating:150V AC/DC

Operating Temperature Range:-40°~+105°C

Electrical

Contact resistance:20m Ohm Max

Insulator resistance:1000M ohm min.

Withstanding Voltage:500V AC/Minute

Material And Finish

Insulator:Nylon 6T UL94V-0 Color:Black

Contact:Brass

Plated:Gold Flash Over Nickel

No.of CKTS	Part No.	No.of CKTS	Part No.
		84	0420041-840100
		88	0420041-880100
		92	0420041-920100
16	0420041-160100	96	0420041-960100
20	0420041-200100	100	0420041-1000100
24	0420041-240100	104	0420041-1040100
28	0420041-280100	108	0420041-1080100
32	0420041-320100	112	0420041-1120100
36	0420041-360100	116	0420041-1160100
40	0420041-400100	120	0420041-1200100
44	0420041-440100	124	0420041-1240100
48	0420041-480100	128	0420041-1280100
52	0420041-520100	132	0420041-1320100
56	0420041-560100	136	0420041-1360100
60	0420041-600100	140	0420041-1400100
64	0420041-640100	144	0420041-1440100
68	0420041-680100	148	0420041-1480100
72	0420041-720100	152	0420041-1520100
76	0420041-760100	156	0420041-1560100
80	0420041-800100	160	0420041-1600100

2.00mm(0.079") Pitch
Pin Header Connector

0420042

Right Angle, Through Hole

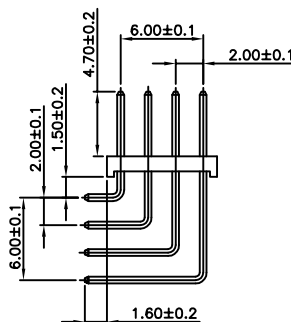
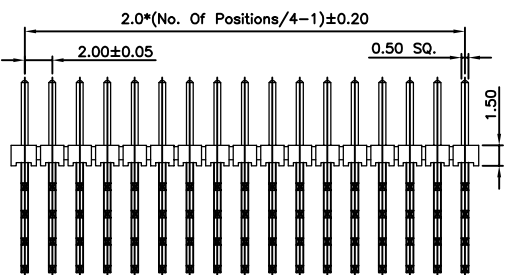
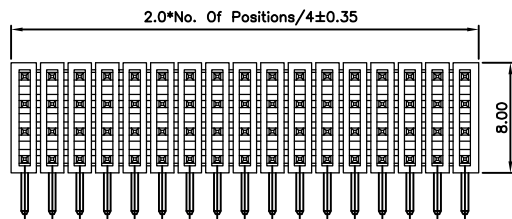

Specifications

Rating

Current Rating:2.0 Amp

Voltage Rating:150V AC/DC

Operating Temperature Range:-40°~+105°C

Electrical

Contact resistance:20m Ohm Max

Insulator resistance:1000M ohm min.

Withstanding Voltage:500V AC/Minute

Material And Finish

Insulator:Nylon 6T UL94V-0 Color:Black

Contact:Brass

Plated:Gold Flash Over Nickel

No.of CKTS	Part No.	No.of CKTS	Part No.
		84	0420042-840100
		88	0420042-880100
		92	0420042-920100
16	0420042-160100	96	0420042-960100
20	0420042-200100	100	0420042-1000100
24	0420042-240100	104	0420042-1040100
28	0420042-280100	108	0420042-1080100
32	0420042-320100	112	0420042-1120100
36	0420042-360100	116	0420042-1160100
40	0420042-400100	120	0420042-1200100
44	0420042-440100	124	0420042-1240100
48	0420042-480100	128	0420042-1280100
52	0420042-520100	132	0420042-1320100
56	0420042-560100	136	0420042-1360100
60	0420042-600100	140	0420042-1400100
64	0420042-640100	144	0420042-1440100
68	0420042-680100	148	0420042-1480100
72	0420042-720100	152	0420042-1520100
76	0420042-760100	156	0420042-1560100
80	0420042-800100	160	0420042-1600100

2.00mm(0.079") Pitch
Pin Header Connector

0420051

Vertical, Through Hole

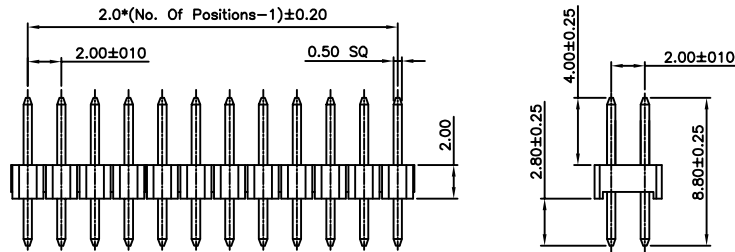
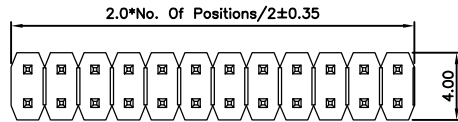

Specifications

Rating

Current Rating:2.0 Amp
Voltage Rating:150V AC/DC
Operating Temperature Range:-40°~+105°C

Electrical

Contact resistance:20m Ohm Max
Insulator resistance:1000M ohm min.
Withstanding Voltage:500V AC/Minute

Material And Finish

Insulator:Nylon 6T UL94V-0 Color:Black
Contact:Brass
Plated:Gold Flash Over Nickel

No.of CKTS	Part No.	No.of CKTS	Part No.
04	0420051-040100	42	0420051-420100
06	0420051-060100	44	0420051-440100
08	0420051-080100	46	0420051-460100
10	0420051-100100	48	0420051-480100
12	0420051-120100	50	0420051-500100
14	0420051-140100	52	0420051-520100
16	0420051-160100	54	0420051-540100
18	0420051-180100	56	0420051-560100
20	0420051-200100	58	0420051-580100
22	0420051-220100	60	0420051-600100
24	0420051-240100	62	0420051-620100
26	0420051-260100	64	0420051-640100
28	0420051-280100	66	0420051-660100
30	0420051-300100	68	0420051-680100
32	0420051-320100	70	0420051-700100
34	0420051-340100	72	0420051-720100
36	0420051-360100	74	0420051-740100
38	0420051-380100	76	0420051-760100
40	0420051-400100	78	0420051-780100
		80	0420051-800100

2.00mm(0.079") Pitch
Pin Header Connector

04200512

Vertical, Through Hole

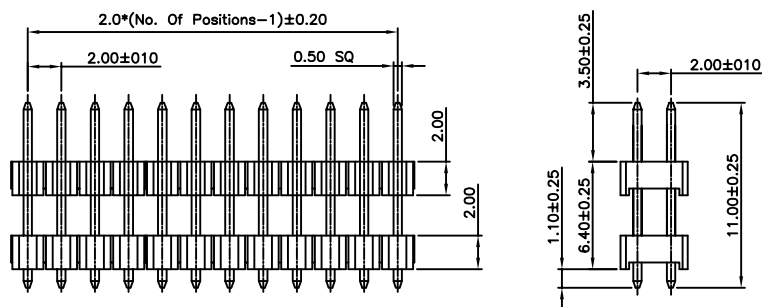
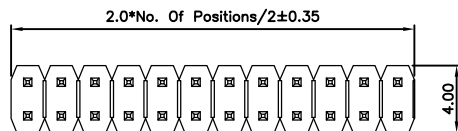

Specifications

Rating

Current Rating:2.0 Amp
Voltage Rating:150V AC/DC
Operating Temperature Range:-40°~+105°C

Electrical

Contact resistance:20m Ohm Max
Insulator resistance:1000M ohm min.
Withstanding Voltage:500V AC/Minute

Material And Finish

Insulator:Nylon 6T UL94V-0 Color:Black
Contact:Brass
Plated:Gold Flash Over Nickel

No.of CKTS	Part No.	No.of CKTS	Part No.
04	04200512-040100	42	04200512-420100
06	04200512-060100	44	04200512-440100
08	04200512-080100	46	04200512-460100
10	04200512-100100	48	04200512-480100
12	04200512-120100	50	04200512-500100
14	04200512-140100	52	04200512-520100
16	04200512-160100	54	04200512-540100
18	04200512-180100	56	04200512-560100
20	04200512-200100	58	04200512-580100
22	04200512-220100	60	04200512-600100
24	04200512-240100	62	04200512-620100
26	04200512-260100	64	04200512-640100
28	04200512-280100	66	04200512-660100
30	04200512-300100	68	04200512-680100
32	04200512-320100	70	04200512-700100
34	04200512-340100	72	04200512-720100
36	04200512-360100	74	04200512-740100
38	04200512-380100	76	04200512-760100
40	04200512-400100	78	04200512-780100
		80	04200512-800100

2.00mm(0.079") Pitch
Pin Header Connector

0420052

Right Angle, Through Hole

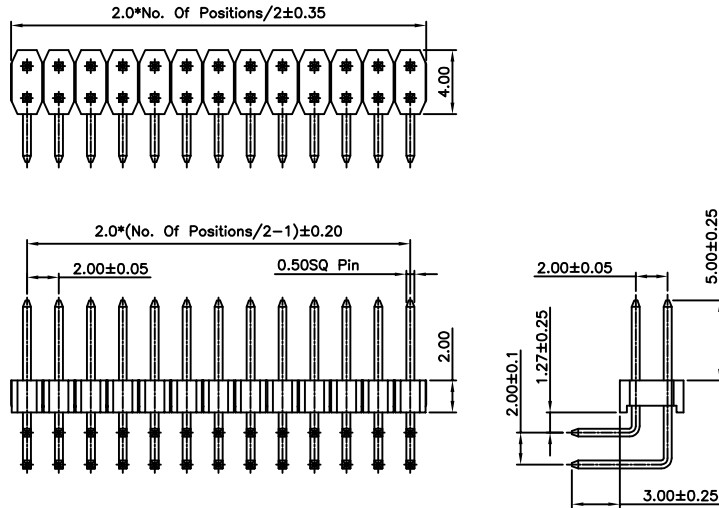

Specifications

Rating

Current Rating:2.0 Amp
Voltage Rating:150V AC/DC
Operating Temperature Range:-40°~+105°C

Electrical

Contact resistance:20m Ohm Max
Insulator resistance:1000M ohm min.
Withstanding Voltage:500V AC/Minute

Material And Finish

Insulator:Nylon 6T UL94V-0 Color:Black
Contact:Brass
Plated:Gold Flash Over Nickel

No.of CKTS	Part No.	No.of CKTS	Part No.
04	0420052-040100	42	0420052-420100
06	0420052-060100	44	0420052-440100
08	0420052-080100	46	0420052-460100
10	0420052-100100	48	0420052-480100
12	0420052-120100	50	0420052-500100
14	0420052-140100	52	0420052-520100
16	0420052-160100	54	0420052-540100
18	0420052-180100	56	0420052-560100
20	0420052-200100	58	0420052-580100
22	0420052-220100	60	0420052-600100
24	0420052-240100	62	0420052-620100
26	0420052-260100	64	0420052-640100
28	0420052-280100	66	0420052-660100
30	0420052-300100	68	0420052-680100
32	0420052-320100	70	0420052-700100
34	0420052-340100	72	0420052-720100
36	0420052-360100	74	0420052-740100
38	0420052-380100	76	0420052-760100
40	0420052-400100	78	0420052-780100
		80	0420052-800100

2.00mm(0.079") Pitch
Pin Header Connector

04200522

Right Angle, Through Hole

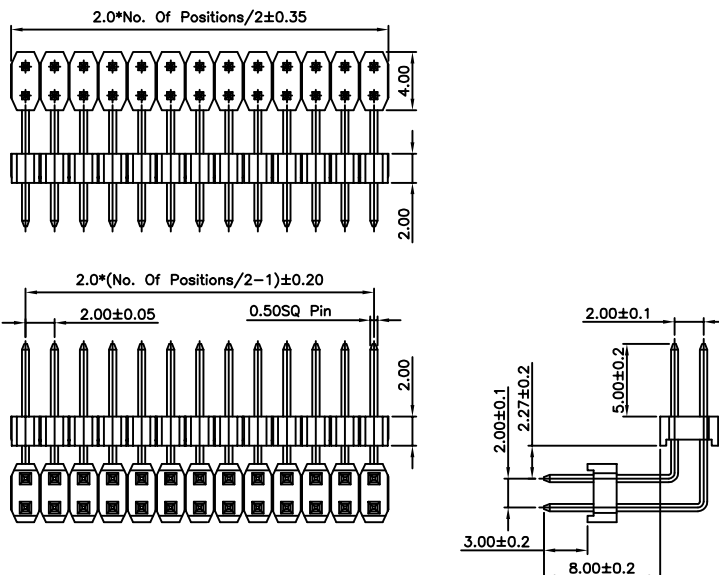

Specifications

Rating

Current Rating:2.0 Amp
Voltage Rating:150V AC/DC
Operating Temperature Range:-40°~+105°C

Electrical

Contact resistance:20m Ohm Max
Insulator resistance:1000M ohm min.
Withstanding Voltage:500V AC/Minute

Material And Finish

Insulator:Nylon 6T UL94V-0 Color:Black
Contact:Brass
Plated:Gold Flash Over Nickel

No.of CKTS	Part No.	No.of CKTS	Part No.
04	04200522-040100	42	04200522-420100
06	04200522-060100	44	04200522-440100
08	04200522-080100	46	04200522-460100
10	04200522-100100	48	04200522-480100
12	04200522-120100	50	04200522-500100
14	04200522-140100	52	04200522-520100
16	04200522-160100	54	04200522-540100
18	04200522-180100	56	04200522-560100
20	04200522-200100	58	04200522-580100
22	04200522-220100	60	04200522-600100
24	04200522-240100	62	04200522-620100
26	04200522-260100	64	04200522-640100
28	04200522-280100	66	04200522-660100
30	04200522-300100	68	04200522-680100
32	04200522-320100	70	04200522-700100
34	04200522-340100	72	04200522-720100
36	04200522-360100	74	04200522-740100
38	04200522-380100	76	04200522-760100
40	04200522-400100	78	04200522-780100
		80	04200522-800100

2.00mm(0.079") Pitch
Pin Header Connector

0420053
Vertical, SMT

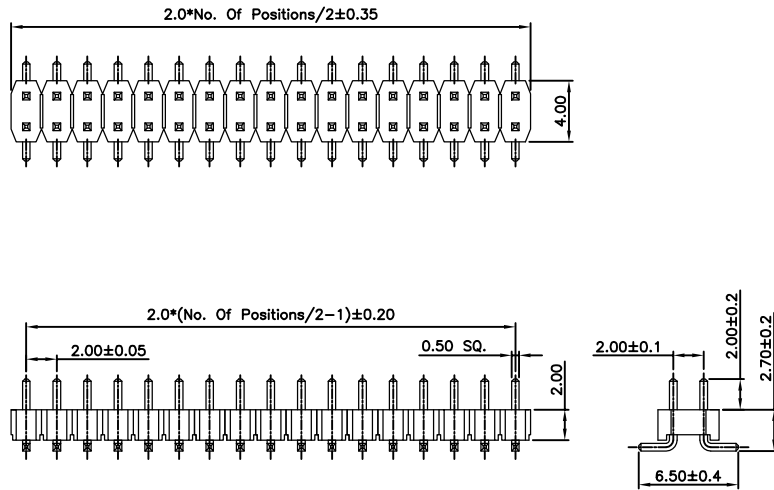

Specifications

Rating

Current Rating:2.0 Amp
Voltage Rating:150V AC/DC
Operating Temperature Range:-40°~+105°C

Electrical

Contact resistance:20m Ohm Max
Insulator resistance:1000M ohm min.
Withstanding Voltage:500V AC/Minute

Material And Finish

Insulator:Nylon 6T UL94V-0 Color:Black
Contact:Brass
Plated:Gold Flash Over Nickel

No.of CKTS	Part No.	No.of CKTS	Part No.
04	0420053-040101	42	0420053-420101
06	0420053-060101	44	0420053-440101
08	0420053-080101	46	0420053-460101
10	0420053-100101	48	0420053-480101
12	0420053-120101	50	0420053-500101
14	0420053-140101	52	0420053-520101
16	0420053-160101	54	0420053-540101
18	0420053-180101	56	0420053-560101
20	0420053-200101	58	0420053-580101
22	0420053-220101	60	0420053-600101
24	0420053-240101	62	0420053-620101
26	0420053-260101	64	0420053-640101
28	0420053-280101	66	0420053-660101
30	0420053-300101	68	0420053-680101
32	0420053-320101	70	0420053-700101
34	0420053-340101	72	0420053-720101
36	0420053-360101	74	0420053-740101
38	0420053-380101	76	0420053-760101
40	0420053-400101	78	0420053-780101
		80	0420053-800101

2.00mm(0.079") Pitch
Pin Header Connector

04200532
Vertical, SMT

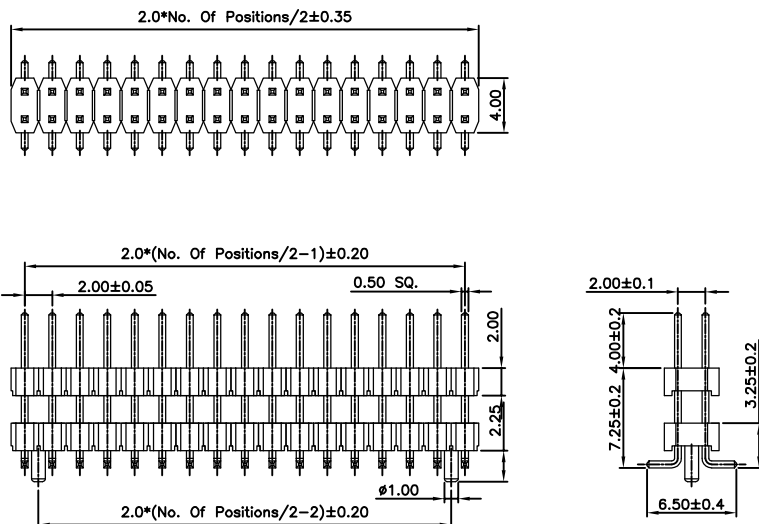

Specifications

Rating

Current Rating:2.0 Amp
Voltage Rating:150V AC/DC
Operating Temperature Range:-40°~+105°C

Electrical

Contact resistance:20m Ohm Max
Insulator resistance:1000M ohm min.
Withstanding Voltage:500V AC/Minute

Material And Finish

Insulator:Nylon 6T UL94V-0 Color:Black
Contact:Brass
Plated:Gold Flash Over Nickel

No.of CKTS	Part No.	No.of CKTS	Part No.
04	04200532-040101	42	04200532-420101
06	04200532-060101	44	04200532-440101
08	04200532-080101	46	04200532-460101
10	04200532-100101	48	04200532-480101
12	04200532-120101	50	04200532-500101
14	04200532-140101	52	04200532-520101
16	04200532-160101	54	04200532-540101
18	04200532-180101	56	04200532-560101
20	04200532-200101	58	04200532-580101
22	04200532-220101	60	04200532-600101
24	04200532-240101	62	04200532-620101
26	04200532-260101	64	04200532-640101
28	04200532-280101	66	04200532-660101
30	04200532-300101	68	04200532-680101
32	04200532-320101	70	04200532-700101
34	04200532-340101	72	04200532-720101
36	04200532-360101	74	04200532-740101
38	04200532-380101	76	04200532-760101
40	04200532-400101	78	04200532-780101
		80	04200532-800101

2.00mm(0.079") Pitch
Pin Header Connector

0420055

Right Angle, SMT

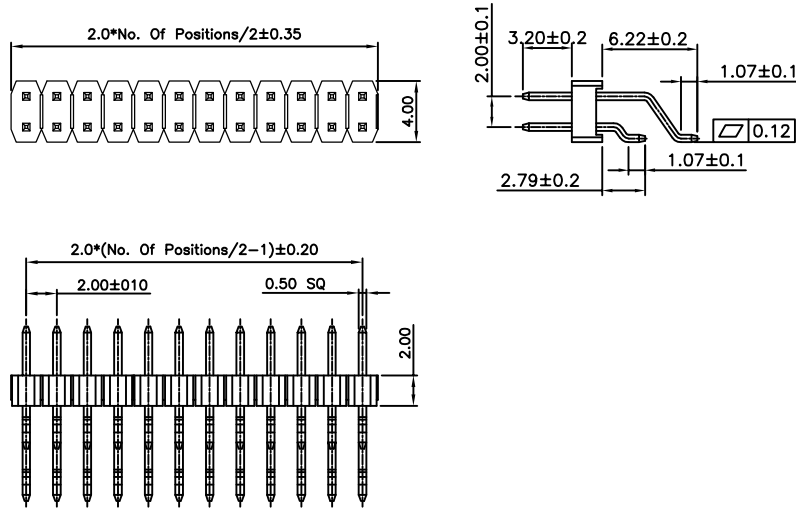

Specifications

Rating

Current Rating:2.0 Amp
Voltage Rating:150V AC/DC
Operating Temperature Range:-40~+105°C

Electrical

Contact resistance:20m Ohm Max
Insulator resistance:1000M ohm min.
Withstanding Voltage:500V AC/Minute

Material And Finish

Insulator:Nylon 6T UL94V-0 Color:Black
Contact:Brass
Plated:Gold Flash Over Nickel

No.of CKTS	Part No.	No.of CKTS	Part No.
04	0420055-040101	42	0420055-420101
06	0420055-060101	44	0420055-440101
08	0420055-080101	46	0420055-460101
10	0420055-100101	48	0420055-480101
12	0420055-120101	50	0420055-500101
14	0420055-140101	52	0420055-520101
16	0420055-160101	54	0420055-540101
18	0420055-180101	56	0420055-560101
20	0420055-200101	58	0420055-580101
22	0420055-220101	60	0420055-600101
24	0420055-240101	62	0420055-620101
26	0420055-260101	64	0420055-640101
28	0420055-280101	66	0420055-660101
30	0420055-300101	68	0420055-680101
32	0420055-320101	70	0420055-700101
34	0420055-340101	72	0420055-720101
36	0420055-360101	74	0420055-740101
38	0420055-380101	76	0420055-760101
40	0420055-400101	78	0420055-780101
		80	0420055-800101

2.00mm(0.079") Pitch
Pin Header Connector

0420056

Right Angle, SMT

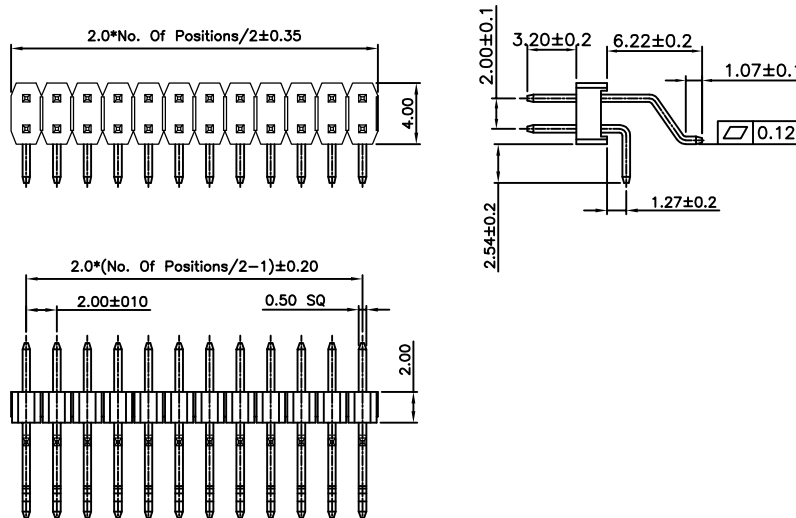

Specifications

Rating

Current Rating:2.0 Amp
Voltage Rating:150V AC/DC
Operating Temperature Range:-40~+105°C

Electrical

Contact resistance:20m Ohm Max
Insulator resistance:1000M ohm min.
Withstanding Voltage:500V AC/Minute

Material And Finish

Insulator:Nylon 6T UL94V-0 Color:Black
Contact:Brass
Plated:Gold Flash Over Nickel

No.of CKTS	Part No.	No.of CKTS	Part No.
04	0420056-040101	42	0420056-420101
06	0420056-060101	44	0420056-440101
08	0420056-080101	46	0420056-460101
10	0420056-100101	48	0420056-480101
12	0420056-120101	50	0420056-500101
14	0420056-140101	52	0420056-520101
16	0420056-160101	54	0420056-540101
18	0420056-180101	56	0420056-560101
20	0420056-200101	58	0420056-580101
22	0420056-220101	60	0420056-600101
24	0420056-240101	62	0420056-620101
26	0420056-260101	64	0420056-640101
28	0420056-280101	66	0420056-660101
30	0420056-300101	68	0420056-680101
32	0420056-320101	70	0420056-700101
34	0420056-340101	72	0420056-720101
36	0420056-360101	74	0420056-740101
38	0420056-380101	76	0420056-760101
40	0420056-400101	78	0420056-780101
		80	0420056-800101

2.00mm(0.079") Pitch
Pin Header Connector

0420061

Vertical, Through Hole

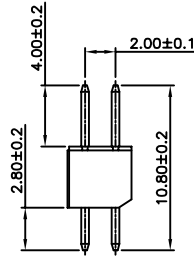
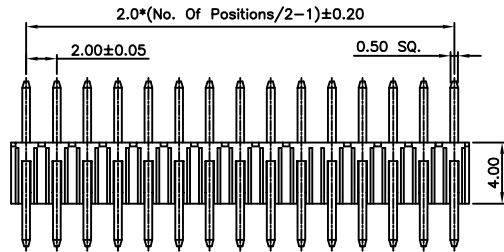
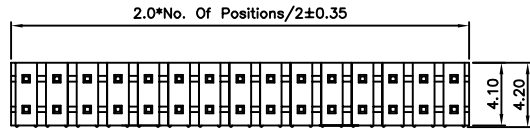

Specifications

Rating

Current Rating:2.0 Amp
Voltage Rating:150V AC/DC
Operating Temperature Range:-40°~+105°C

Electrical

Contact resistance:20m Ohm Max
Insulator resistance:1000M ohm min.
Withstanding Voltage:500V AC/Minute

Material And Finish

Insulator:Nylon 6T UL94V-0 Color:Black
Contact:Brass
Plated:Gold Flash Over Nickel

No.of CKTS	Part No.	No.of CKTS	Part No.
04	0420061-040100	42	0420061-420100
06	0420061-060100	44	0420061-440100
08	0420061-080100	46	0420061-460100
10	0420061-100100	48	0420061-480100
12	0420061-120100	50	0420061-500100
14	0420061-140100	52	0420061-520100
16	0420061-160100	54	0420061-540100
18	0420061-180100	56	0420061-560100
20	0420061-200100	58	0420061-580100
22	0420061-220100	60	0420061-600100
24	0420061-240100	62	0420061-620100
26	0420061-260100	64	0420061-640100
28	0420061-280100	66	0420061-660100
30	0420061-300100	68	0420061-680100
32	0420061-320100	70	0420061-700100
34	0420061-340100	72	0420061-720100
36	0420061-360100	74	0420061-740100
38	0420061-380100	76	0420061-760100
40	0420061-400100	78	0420061-780100
		80	0420061-800100

2.00mm(0.079") Pitch
Pin Header Connector

0420062

Right Angle, Through Hole

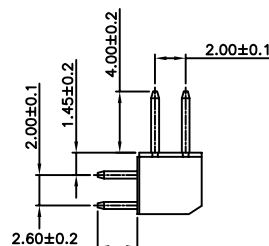
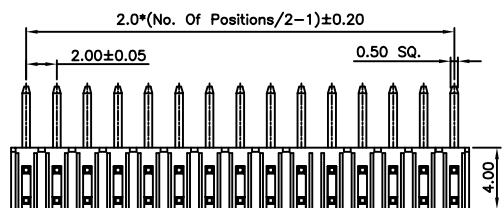
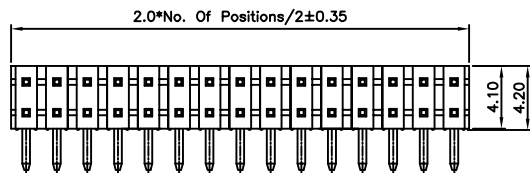

Specifications

Rating

Current Rating:2.0 Amp
Voltage Rating:150V AC/DC
Operating Temperature Range:-40°~+105°C

Electrical

Contact resistance:20m Ohm Max
Insulator resistance:1000M ohm min.
Withstanding Voltage:500V AC/Minute

Material And Finish

Insulator:Nylon 6T UL94V-0 Color:Black
Contact:Brass
Plated:Gold Flash Over Nickel

No.of CKTS	Part No.	No.of CKTS	Part No.
04	0420062-040101	42	0420062-420101
06	0420062-060101	44	0420062-440101
08	0420062-080101	46	0420062-460101
10	0420062-100101	48	0420062-480101
12	0420062-120101	50	0420062-500101
14	0420062-140101	52	0420062-520101
16	0420062-160101	54	0420062-540101
18	0420062-180101	56	0420062-560101
20	0420062-200101	58	0420062-580101
22	0420062-220101	60	0420062-600101
24	0420062-240101	62	0420062-620101
26	0420062-260101	64	0420062-640101
28	0420062-280101	66	0420062-660101
30	0420062-300101	68	0420062-680101
32	0420062-320101	70	0420062-700101
34	0420062-340101	72	0420062-720101
36	0420062-360101	74	0420062-740101
38	0420062-380101	76	0420062-760101
40	0420062-400101	78	0420062-780101
		80	0420062-800101

2.00mm(0.079") Pitch
Pin Header Connector

0420065

Right Angle, SMT

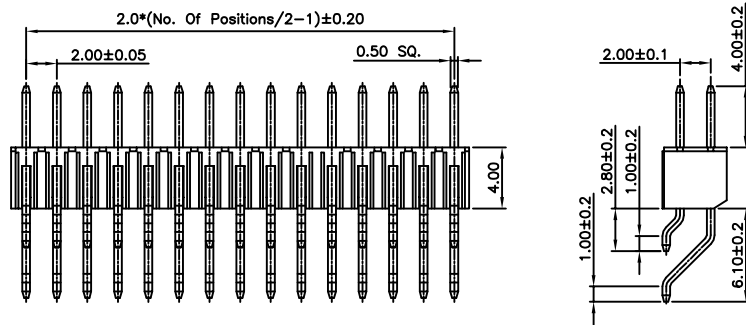
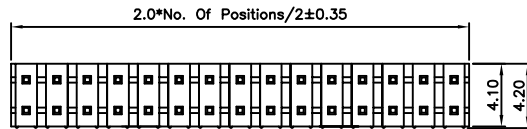

Specifications

Rating

Current Rating:2.0 Amp
Voltage Rating:150V AC/DC
Operating Temperature Range:-40°~+105°C

Electrical

Contact resistance:20m Ohm Max
Insulator resistance:1000M ohm min.
Withstanding Voltage:500V AC/Minute

Material And Finish

Insulator:Nylon 6T UL94V-0 Color:Black
Contact:Brass
Plated:Gold Flash Over Nickel

No.of CKTS	Part No.	No.of CKTS	Part No.
04	0420065-040101	42	0420065-420101
06	0420065-060101	44	0420065-440101
08	0420065-080101	46	0420065-460101
10	0420065-100101	48	0420065-480101
12	0420065-120101	50	0420065-500101
14	0420065-140101	52	0420065-520101
16	0420065-160101	54	0420065-540101
18	0420065-180101	56	0420065-560101
20	0420065-200101	58	0420065-580101
22	0420065-220101	60	0420065-600101
24	0420065-240101	62	0420065-620101
26	0420065-260101	64	0420065-640101
28	0420065-280101	66	0420065-660101
30	0420065-300101	68	0420065-680101
32	0420065-320101	70	0420065-700101
34	0420065-340101	72	0420065-720101
36	0420065-360101	74	0420065-740101
38	0420065-380101	76	0420065-760101
40	0420065-400101	78	0420065-780101
		80	0420065-800101

2.00mm(0.079") Pitch
Pin Header Connector

0420071

Vertical, Through Hole

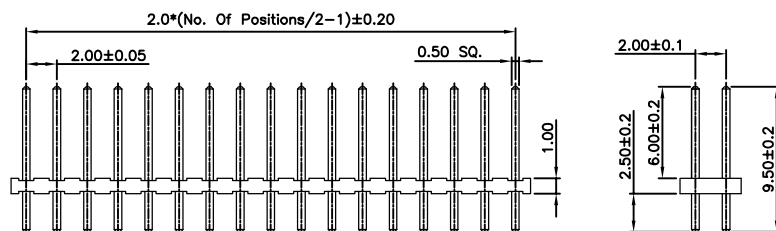
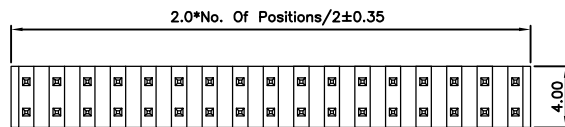

Specifications

Rating

Current Rating:2.0 Amp
Voltage Rating:150V AC/DC
Operating Temperature Range:-40°~+105°C

Electrical

Contact resistance:20m Ohm Max
Insulator resistance:1000M ohm min.
Withstanding Voltage:500V AC/Minute

Material And Finish

Insulator:Nylon 6T UL94V-0 Color:Black
Contact:Brass
Plated:Gold Flash Over Nickel

No.of CKTS	Part No.	No.of CKTS	Part No.
04	0420071-040100	42	0420071-420100
06	0420071-060100	44	0420071-440100
08	0420071-080100	46	0420071-460100
10	0420071-100100	48	0420071-480100
12	0420071-120100	50	0420071-500100
14	0420071-140100	52	0420071-520100
16	0420071-160100	54	0420071-540100
18	0420071-180100	56	0420071-560100
20	0420071-200100	58	0420071-580100
22	0420071-220100	60	0420071-600100
24	0420071-240100	62	0420071-620100
26	0420071-260100	64	0420071-640100
28	0420071-280100	66	0420071-660100
30	0420071-300100	68	0420071-680100
32	0420071-320100	70	0420071-700100
34	0420071-340100	72	0420071-720100
36	0420071-360100	74	0420071-740100
38	0420071-380100	76	0420071-760100
40	0420071-400100	78	0420071-780100
		80	0420071-800100

2.00mm(0.079") Pitch
Pin Header Connector

0420072

Right Angle, Through Hole

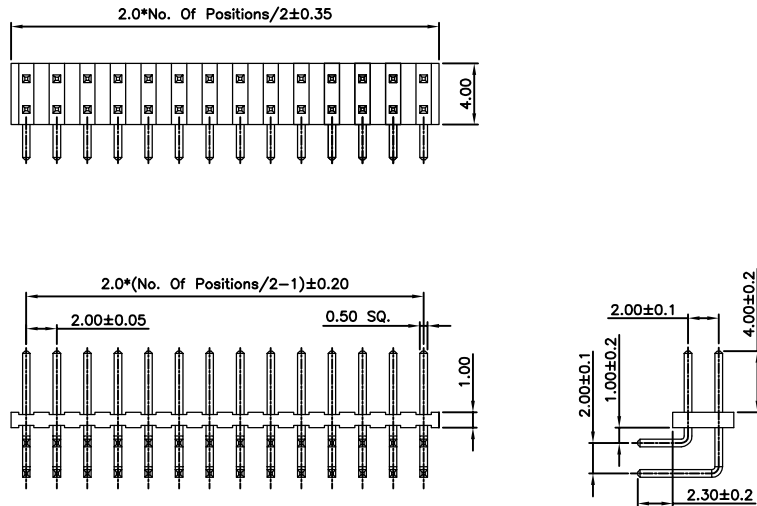

Specifications

Rating

Current Rating:2.0 Amp
Voltage Rating:150V AC/DC
Operating Temperature Range:-40°~+105°C

Electrical

Contact resistance:20m Ohm Max
Insulator resistance:1000M ohm min.
Withstanding Voltage:500V AC/Minute

Material And Finish

Insulator:Nylon 6T UL94V-0 Color:Black
Contact:Brass
Plated:Gold Flash Over Nickel

No.of CKTS	Part No.	No.of CKTS	Part No.
04	0420072-040100	42	0420072-420100
06	0420072-060100	44	0420072-440100
08	0420072-080100	46	0420072-460100
10	0420072-100100	48	0420072-480100
12	0420072-120100	50	0420072-500100
14	0420072-140100	52	0420072-520100
16	0420072-160100	54	0420072-540100
18	0420072-180100	56	0420072-560100
20	0420072-200100	58	0420072-580100
22	0420072-220100	60	0420072-600100
24	0420072-240100	62	0420072-620100
26	0420072-260100	64	0420072-640100
28	0420072-280100	66	0420072-660100
30	0420072-300100	68	0420072-680100
32	0420072-320100	70	0420072-700100
34	0420072-340100	72	0420072-720100
36	0420072-360100	74	0420072-740100
38	0420072-380100	76	0420072-760100
40	0420072-400100	78	0420072-780100
		80	0420072-800100

2.00mm(0.079") Pitch
Pin Header Connector

0420073

Vertical, SMT

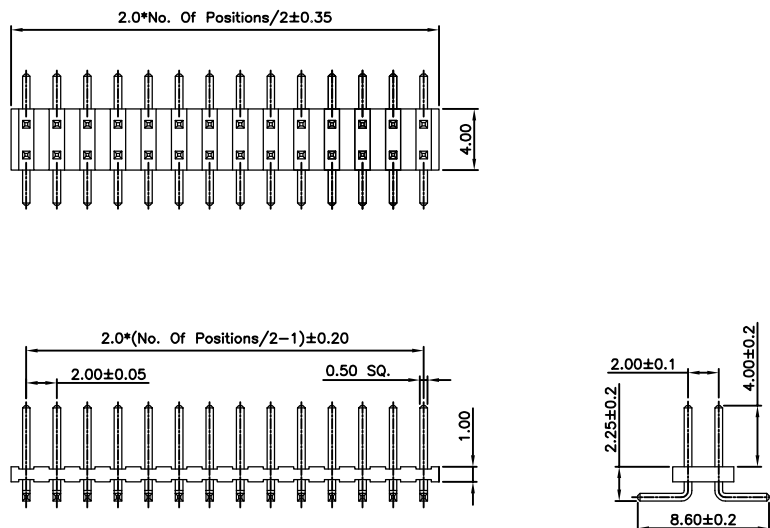

Specifications

Rating

Current Rating:2.0 Amp
Voltage Rating:150V AC/DC
Operating Temperature Range:-40°~+105°C

Electrical

Contact resistance:20m Ohm Max
Insulator resistance:1000M ohm min.
Withstanding Voltage:500V AC/Minute

Material And Finish

Insulator:Nylon 6T UL94V-0 Color:Black
Contact:Brass
Plated:Gold Flash Over Nickel

No.of CKTS	Part No.	No.of CKTS	Part No.
04	0420073-040101	42	0420073-420101
06	0420073-060101	44	0420073-440101
08	0420073-080101	46	0420073-460101
10	0420073-100101	48	0420073-480101
12	0420073-120101	50	0420073-500101
14	0420073-140101	52	0420073-520101
16	0420073-160101	54	0420073-540101
18	0420073-180101	56	0420073-560101
20	0420073-200101	58	0420073-580101
22	0420073-220101	60	0420073-600101
24	0420073-240101	62	0420073-620101
26	0420073-260101	64	0420073-640101
28	0420073-280101	66	0420073-660101
30	0420073-300101	68	0420073-680101
32	0420073-320101	70	0420073-700101
34	0420073-340101	72	0420073-720101
36	0420073-360101	74	0420073-740101
38	0420073-380101	76	0420073-760101
40	0420073-400101	78	0420073-780101
		80	0420073-800101

2.54mm(0.10") Pitch
Pin Header Connector

0425011
Vertical, Through Hole

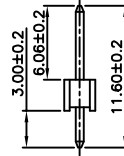
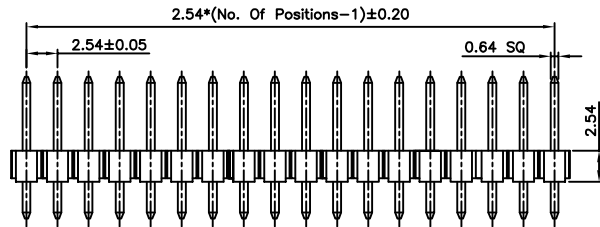
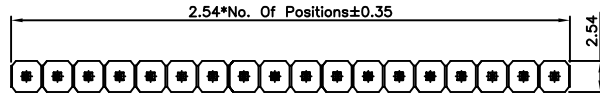

Specifications

Rating

Current Rating:3.0 Amp
Voltage Rating:250V AC/DC
Operating Temperature Range:-40°~+105°C

Electrical

Contact resistance:20m Ohm Max
Insulator resistance:1000M ohm min.
Withstanding Voltage:500V AC/Minute

Material And Finish

Insulator:Nylon 6T UL94V-0 Color:Black
Contact:Brass
Plated:Gold Flash Over Nickel

No.of CKTS	Part No.	No.of CKTS	Part No.
01	0425011-010100	21	0425011-210100
02	0425011-020100	22	0425011-220100
03	0425011-030100	23	0425011-230100
04	0425011-040100	24	0425011-240100
05	0425011-050100	25	0425011-250100
06	0425011-060100	26	0425011-260100
07	0425011-070100	27	0425011-270100
08	0425011-080100	28	0425011-280100
09	0425011-090100	29	0425011-290100
10	0425011-100100	30	0425011-300100
11	0425011-110100	31	0425011-310100
12	0425011-120100	32	0425011-320100
13	0425011-130100	33	0425011-330100
14	0425011-140100	34	0425011-340100
15	0425011-150100	35	0425011-350100
16	0425011-160100	36	0425011-360100
17	0425011-170100	37	0425011-370100
18	0425011-180100	38	0425011-380100
19	0425011-190100	39	0425011-390100
20	0425011-200100	40	0425011-400100

2.54mm(0.10") Pitch
Pin Header Connector

0425012
Vertical, Through Hole

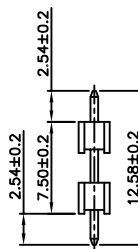
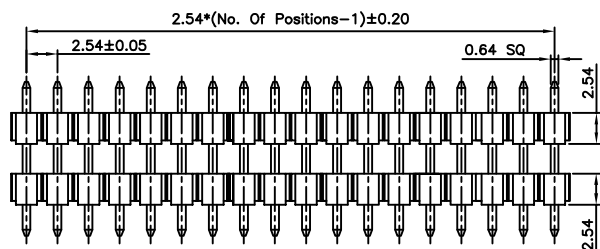
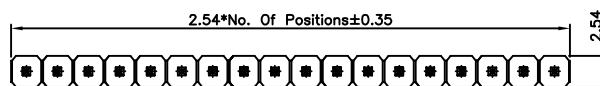

Specifications

Rating

Current Rating:3.0 Amp
Voltage Rating:250V AC/DC
Operating Temperature Range:-40°~+105°C

Electrical

Contact resistance:20m Ohm Max
Insulator resistance:1000M ohm min.
Withstanding Voltage:500V AC/Minute

Material And Finish

Insulator:Nylon 6T UL94V-0 Color:Black
Contact:Brass
Plated:Gold Flash Over Nickel

No.of CKTS	Part No.	No.of CKTS	Part No.
01	0425012-010100	21	0425012-210100
02	0425012-020100	22	0425012-220100
03	0425012-030100	23	0425012-230100
04	0425012-040100	24	0425012-240100
05	0425012-050100	25	0425012-250100
06	0425012-060100	26	0425012-260100
07	0425012-070100	27	0425012-270100
08	0425012-080100	28	0425012-280100
09	0425012-090100	29	0425012-290100
10	0425012-100100	30	0425012-300100
11	0425012-110100	31	0425012-310100
12	0425012-120100	32	0425012-320100
13	0425012-130100	33	0425012-330100
14	0425012-140100	34	0425012-340100
15	0425012-150100	35	0425012-350100
16	0425012-160100	36	0425012-360100
17	0425012-170100	37	0425012-370100
18	0425012-180100	38	0425012-380100
19	0425012-190100	39	0425012-390100
20	0425012-200100	40	0425012-400100

2.54mm(0.10") Pitch
Pin Header Connector

0425012

Right Angle, Through Hole

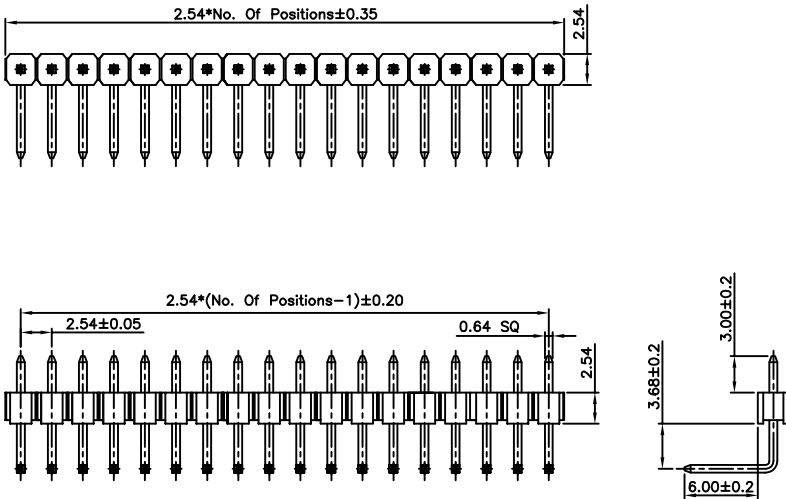

Specifications

Rating

Current Rating:3.0 Amp
Voltage Rating:250V AC/DC
Operating Temperature Range:-40°~+105°C

Electrical

Contact resistance:20m Ohm Max
Insulator resistance:1000M ohm min.
Withstanding Voltage:500V AC/Minute

Material And Finish

Insulator:Nylon 6T UL94V-0 Color:Black
Contact:Brass
Plated:Gold Flash Over Nickel

No.of CKTS	Part No.	No.of CKTS	Part No.
01	0425012-010100	21	0425012-210100
02	0425012-020100	22	0425012-220100
03	0425012-030100	23	0425012-230100
04	0425012-040100	24	0425012-240100
05	0425012-050100	25	0425012-250100
06	0425012-060100	26	0425012-260100
07	0425012-070100	27	0425012-270100
08	0425012-080100	28	0425012-280100
09	0425012-090100	29	0425012-290100
10	0425012-100100	30	0425012-300100
11	0425012-110100	31	0425012-310100
12	0425012-120100	32	0425012-320100
13	0425012-130100	33	0425012-330100
14	0425012-140100	34	0425012-340100
15	0425012-150100	35	0425012-350100
16	0425012-160100	36	0425012-360100
17	0425012-170100	37	0425012-370100
18	0425012-180100	38	0425012-380100
19	0425012-190100	39	0425012-390100
20	0425012-200100	40	0425012-400100

2.54mm(0.10") Pitch
Pin Header Connector

04250122

Right Angle, Through Hole

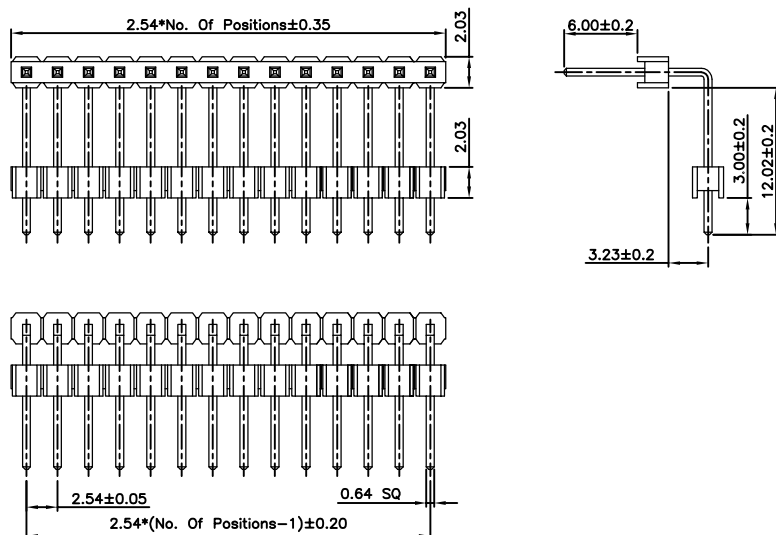

Specifications

Rating

Current Rating:3.0 Amp
Voltage Rating:250V AC/DC
Operating Temperature Range:-40°~+105°C

Electrical

Contact resistance:20m Ohm Max
Insulator resistance:1000M ohm min.
Withstanding Voltage:500V AC/Minute

Material And Finish

Insulator:Nylon 6T UL94V-0 Color:Black
Contact:Brass
Plated:Gold Flash Over Nickel

No.of CKTS	Part No.	No.of CKTS	Part No.
01	04250122-010100	21	04250122-210100
02	04250122-020100	22	04250122-220100
03	04250122-030100	23	04250122-230100
04	04250122-040100	24	04250122-240100
05	04250122-050100	25	04250122-250100
06	04250122-060100	26	04250122-260100
07	04250122-070100	27	04250122-270100
08	04250122-080100	28	04250122-280100
09	04250122-090100	29	04250122-290100
10	04250122-100100	30	04250122-300100
11	04250122-110100	31	04250122-310100
12	04250122-120100	32	04250122-320100
13	04250122-130100	33	04250122-330100
14	04250122-140100	34	04250122-340100
15	04250122-150100	35	04250122-350100
16	04250122-160100	36	04250122-360100
17	04250122-170100	37	04250122-370100
18	04250122-180100	38	04250122-380100
19	04250122-190100	39	04250122-390100
20	04250122-200100	40	04250122-400100

2.54mm(0.10") Pitch
Pin Header Connector

0425013
Vertical, SMT

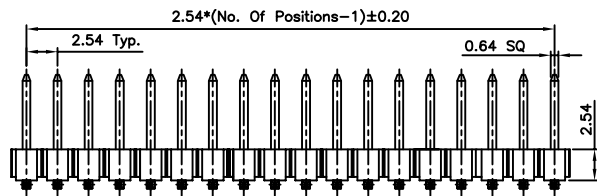
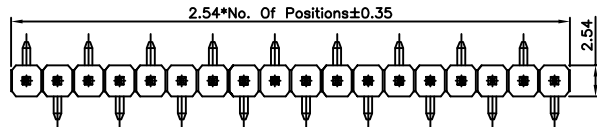

Specifications

Rating

Current Rating:3.0 Amp
Voltage Rating:250V AC/DC
Operating Temperature Range:-40°~+105°C

Electrical

Contact resistance:20m Ohm Max
Insulator resistance:1000M ohm min.
Withstanding Voltage:500V AC/Minute

Material And Finish

Insulator:Nylon 6T UL94V-0 Color:Black
Contact:Brass
Plated:Gold Flash Over Nickel

No.of CKTS	Part No.	No.of CKTS	Part No.
01	0425013-010101	21	0425013-210101
02	0425013-020101	22	0425013-220101
03	0425013-030101	23	0425013-230101
04	0425013-040101	24	0425013-240101
05	0425013-050101	25	0425013-250101
06	0425013-060101	26	0425013-260101
07	0425013-070101	27	0425013-270101
08	0425013-080101	28	0425013-280101
09	0425013-090101	29	0425013-290101
10	0425013-100101	30	0425013-300101
11	0425013-110101	31	0425013-310101
12	0425013-120101	32	0425013-320101
13	0425013-130101	33	0425013-330101
14	0425013-140101	34	0425013-340101
15	0425013-150101	35	0425013-350101
16	0425013-160101	36	0425013-360101
17	0425013-170101	37	0425013-370101
18	0425013-180101	38	0425013-380101
19	0425013-190101	39	0425013-390101
20	0425013-200101	40	0425013-400101

2.54mm(0.10") Pitch
Pin Header Connector

04250132
Vertical, SMT

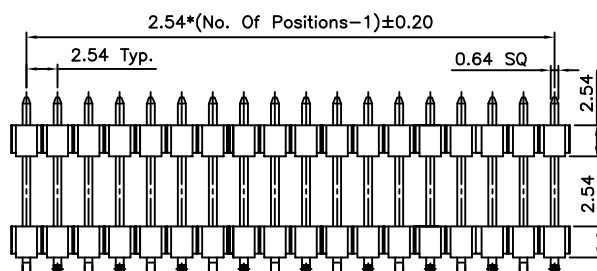
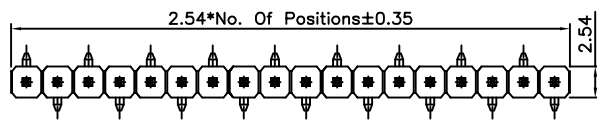

Specifications

Rating

Current Rating:3.0 Amp
Voltage Rating:250V AC/DC
Operating Temperature Range:-40°~+105°C

Electrical

Contact resistance:20m Ohm Max
Insulator resistance:1000M ohm min.
Withstanding Voltage:500V AC/Minute

Material And Finish

Insulator:Nylon 6T UL94V-0 Color:Black
Contact:Brass
Plated:Gold Flash Over Nickel

No.of CKTS	Part No.	No.of CKTS	Part No.
01	04250132-010101	21	04250132-210101
02	04250132-020101	22	04250132-220101
03	04250132-030101	23	04250132-230101
04	04250132-040101	24	04250132-240101
05	04250132-050101	25	04250132-250101
06	04250132-060101	26	04250132-260101
07	04250132-070101	27	04250132-270101
08	04250132-080101	28	04250132-280101
09	04250132-090101	29	04250132-290101
10	04250132-100101	30	04250132-300101
11	04250132-110101	31	04250132-310101
12	04250132-120101	32	04250132-320101
13	04250132-130101	33	04250132-330101
14	04250132-140101	34	04250132-340101
15	04250132-150101	35	04250132-350101
16	04250132-160101	36	04250132-360101
17	04250132-170101	37	04250132-370101
18	04250132-180101	38	04250132-380101
19	04250132-190101	39	04250132-390101
20	04250132-200101	40	04250132-400101

2.54mm(0.10") Pitch
Pin Header Connector

0425021
Vertical, Through Hole

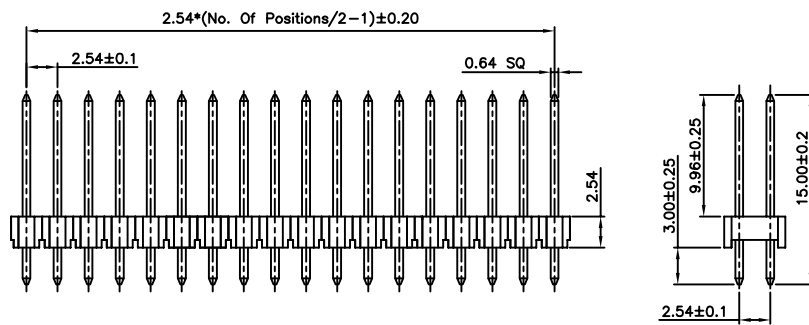
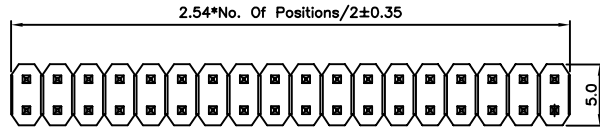

Specifications

Rating

Current Rating:3.0 Amp
Voltage Rating:250V AC/DC
Operating Temperature Range:-40°~+105°C

Electrical

Contact resistance:20m Ohm Max
Insulator resistance:1000M ohm min.
Withstanding Voltage:500V AC/Minute

Material And Finish

Insulator:Nylon 6T UL94V-0 Color:Black
Contact:Brass
Plated:Gold Flash Over Nickel

No.of CKTS	Part No.	No.of CKTS	Part No.
04	0425021-040100	42	0425021-420100
06	0425021-060100	44	0425021-440100
08	0425021-080100	46	0425021-460100
10	0425021-100100	48	0425021-480100
12	0425021-120100	50	0425021-500100
14	0425021-140100	52	0425021-520100
16	0425021-160100	54	0425021-540100
18	0425021-180100	56	0425021-560100
20	0425021-200100	58	0425021-580100
22	0425021-220100	60	0425021-600100
24	0425021-240100	62	0425021-620100
26	0425021-260100	64	0425021-640100
28	0425021-280100	66	0425021-660100
30	0425021-300100	68	0425021-680100
32	0425021-320100	70	0425021-700100
34	0425021-340100	72	0425021-720100
36	0425021-360100	74	0425021-740100
38	0425021-380100	76	0425021-760100
40	0425021-400100	78	0425021-780100
		80	0425021-800100

2.54mm(0.10") Pitch
Pin Header Connector

0425022
Vertical, Through Hole

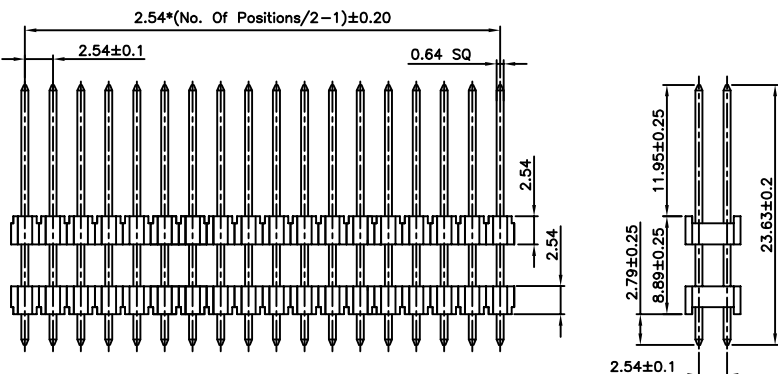
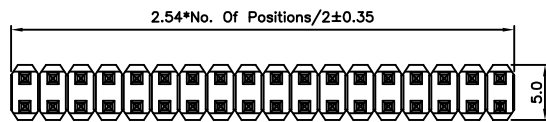

Specifications

Rating

Current Rating:3.0 Amp
Voltage Rating:250V AC/DC
Operating Temperature Range:-40°~+105°C

Electrical

Contact resistance:20m Ohm Max
Insulator resistance:1000M ohm min.
Withstanding Voltage:500V AC/Minute

Material And Finish

Insulator:Nylon 6T UL94V-0 Color:Black
Contact:Brass
Plated:Gold Flash Over Nickel

No.of CKTS	Part No.	No.of CKTS	Part No.
04	04250212-040100	42	04250212-420100
06	04250212-060100	44	04250212-440100
08	04250212-080100	46	04250212-460100
10	04250212-100100	48	04250212-480100
12	04250212-120100	50	04250212-500100
14	04250212-140100	52	04250212-520100
16	04250212-160100	54	04250212-540100
18	04250212-180100	56	04250212-560100
20	04250212-200100	58	04250212-580100
22	04250212-220100	60	04250212-600100
24	04250212-240100	62	04250212-620100
26	04250212-260100	64	04250212-640100
28	04250212-280100	66	04250212-660100
30	04250212-300100	68	04250212-680100
32	04250212-320100	70	04250212-700100
34	04250212-340100	72	04250212-720100
36	04250212-360100	74	04250212-740100
38	04250212-380100	76	04250212-760100
40	04250212-400100	78	04250212-780100
		80	04250212-800100

2.54mm(0.10") Pitch
Pin Header Connector

0425022
Right Angle, Through Hole

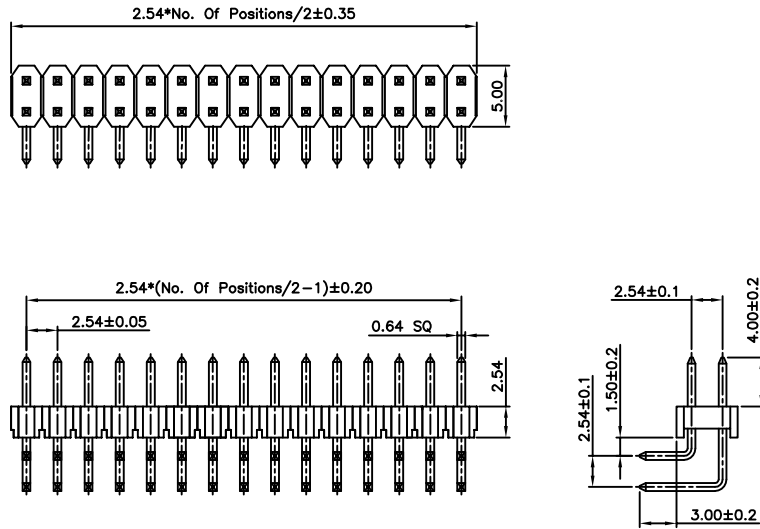

Specifications

Rating

Current Rating:3.0 Amp
Voltage Rating:250V AC/DC
Operating Temperature Range:-40~+105°C

Electrical

Contact resistance:20m Ohm Max
Insulator resistance:1000M ohm min.
Withstanding Voltage:500V AC/Minute

Material And Finish

Insulator:Nylon 6T UL94V-0 Color:Black
Contact:Brass
Plated:Gold Flash Over Nickel

No.of CKTS	Part No.	No.of CKTS	Part No.
04	0425022-040100	42	0425022-420100
06	0425022-060100	44	0425022-440100
08	0425022-080100	46	0425022-460100
10	0425022-100100	48	0425022-480100
12	0425022-120100	50	0425022-500100
14	0425022-140100	52	0425022-520100
16	0425022-160100	54	0425022-540100
18	0425022-180100	56	0425022-560100
20	0425022-200100	58	0425022-580100
22	0425022-220100	60	0425022-600100
24	0425022-240100	62	0425022-620100
26	0425022-260100	64	0425022-640100
28	0425022-280100	66	0425022-660100
30	0425022-300100	68	0425022-680100
32	0425022-320100	70	0425022-700100
34	0425022-340100	72	0425022-720100
36	0425022-360100	74	0425022-740100
38	0425022-380100	76	0425022-760100
40	0425022-400100	78	0425022-780100
		80	0425022-800100

2.54mm(0.10") Pitch
Pin Header Connector

04250222
Right Angle, Through Hole

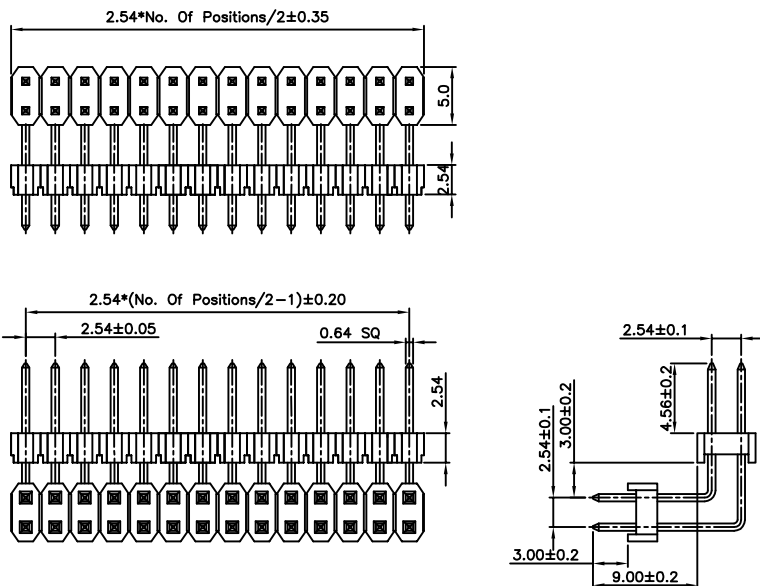

Specifications

Rating

Current Rating:3.0 Amp
Voltage Rating:250V AC/DC
Operating Temperature Range:-40~+105°C

Electrical

Contact resistance:20m Ohm Max
Insulator resistance:1000M ohm min.
Withstanding Voltage:500V AC/Minute

Material And Finish

Insulator:Nylon 6T UL94V-0 Color:Black
Contact:Brass
Plated:Gold Flash Over Nickel

No.of CKTS	Part No.	No.of CKTS	Part No.
04	04250222-040100	42	04250222-420100
06	04250222-060100	44	04250222-440100
08	04250222-080100	46	04250222-460100
10	04250222-100100	48	04250222-480100
12	04250222-120100	50	04250222-500100
14	04250222-140100	52	04250222-520100
16	04250222-160100	54	04250222-540100
18	04250222-180100	56	04250222-560100
20	04250222-200100	58	04250222-580100
22	04250222-220100	60	04250222-600100
24	04250222-240100	62	04250222-620100
26	04250222-260100	64	04250222-640100
28	04250222-280100	66	04250222-660100
30	04250222-300100	68	04250222-680100
32	04250222-320100	70	04250222-700100
34	04250222-340100	72	04250222-720100
36	04250222-360100	74	04250222-740100
38	04250222-380100	76	04250222-760100
40	04250222-400100	78	04250222-780100
		80	04250222-800100

2.54mm(0.10") Pitch
Pin Header Connector

0425023
Vertical, SMT

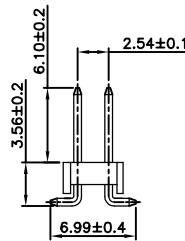
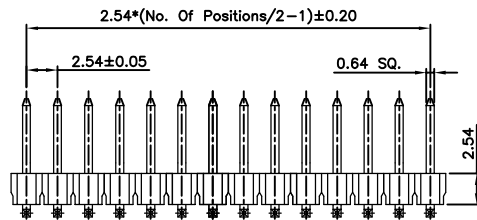
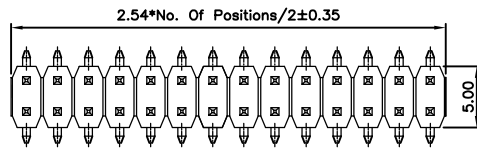

Specifications

Rating

Current Rating:3.0 Amp
Voltage Rating:250V AC/DC
Operating Temperature Range:-40°~+105°C

Electrical

Contact resistance:20m Ohm Max
Insulator resistance:1000M ohm min.
Withstanding Voltage:500V AC/Minute

Material And Finish

Insulator:Nylon 6T UL94V-0 Color:Black
Contact:Brass
Plated:Gold Flash Over Nickel

No.of CKTS	Part No.	No.of CKTS	Part No.
04	0425023-040101	42	0425023-420101
06	0425023-060101	44	0425023-440101
08	0425023-080101	46	0425023-460101
10	0425023-100101	48	0425023-480101
12	0425023-120101	50	0425023-500101
14	0425023-140101	52	0425023-520101
16	0425023-160101	54	0425023-540101
18	0425023-180101	56	0425023-560101
20	0425023-200101	58	0425023-580101
22	0425023-220101	60	0425023-600101
24	0425023-240101	62	0425023-620101
26	0425023-260101	64	0425023-640101
28	0425023-280101	66	0425023-660101
30	0425023-300101	68	0425023-680101
32	0425023-320101	70	0425023-700101
34	0425023-340101	72	0425023-720101
36	0425023-360101	74	0425023-740101
38	0425023-380101	76	0425023-760101
40	0425023-400101	78	0425023-780101
		80	0425023-800101

2.54mm(0.10") Pitch
Pin Header Connector

04250232
Vertical, SMT

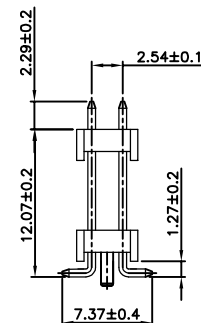
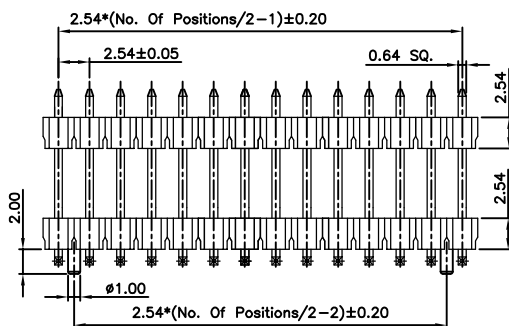
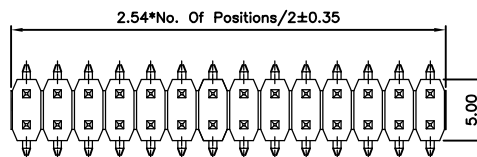

Specifications

Rating

Current Rating:3.0 Amp
Voltage Rating:250V AC/DC
Operating Temperature Range:-40°~+105°C

Electrical

Contact resistance:20m Ohm Max
Insulator resistance:1000M ohm min.
Withstanding Voltage:500V AC/Minute

Material And Finish

Insulator:Nylon 6T UL94V-0 Color:Black
Contact:Brass
Plated:Gold Flash Over Nickel

No.of CKTS	Part No.	No.of CKTS	Part No.
04	04250232-040101	42	04250232-420101
06	04250232-060101	44	04250232-440101
08	04250232-080101	46	04250232-460101
10	04250232-100101	48	04250232-480101
12	04250232-120101	50	04250232-500101
14	04250232-140101	52	04250232-520101
16	04250232-160101	54	04250232-540101
18	04250232-180101	56	04250232-560101
20	04250232-200101	58	04250232-580101
22	04250232-220101	60	04250232-600101
24	04250232-240101	62	04250232-620101
26	04250232-260101	64	04250232-640101
28	04250232-280101	66	04250232-660101
30	04250232-300101	68	04250232-680101
32	04250232-320101	70	04250232-700101
34	04250232-340101	72	04250232-720101
36	04250232-360101	74	04250232-740101
38	04250232-380101	76	04250232-760101
40	04250232-400101	78	04250232-780101
		80	04250232-800101

2.54mm(0.10") Pitch
Pin Header Connector

0425025

Right Angle, SMT

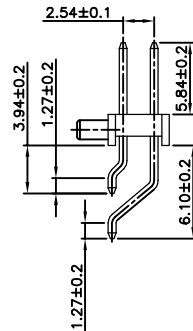
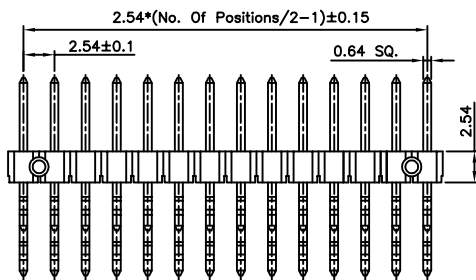
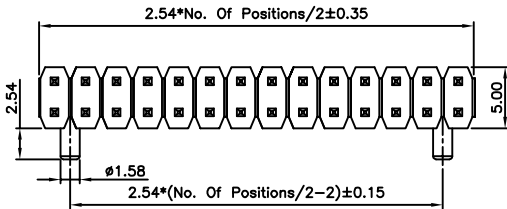

Specifications

Rating

Current Rating:3.0 Amp
Voltage Rating:250V AC/DC
Operating Temperature Range:-40°~+105°C

Electrical

Contact resistance:20m Ohm Max
Insulator resistance:1000M ohm min.
Withstanding Voltage:500V AC/Minute

Material And Finish

Insulator:Nylon 6T UL94V-0 Color:Black
Contact:Brass
Plated:Gold Flash Over Nickel

No.of CKTS	Part No.	No.of CKTS	Part No.
04	0425025-040101	42	0425025-420101
06	0425025-060101	44	0425025-440101
08	0425025-080101	46	0425025-460101
10	0425025-100101	48	0425025-480101
12	0425025-120101	50	0425025-500101
14	0425025-140101	52	0425025-520101
16	0425025-160101	54	0425025-540101
18	0425025-180101	56	0425025-560101
20	0425025-200101	58	0425025-580101
22	0425025-220101	60	0425025-600101
24	0425025-240101	62	0425025-620101
26	0425025-260101	64	0425025-640101
28	0425025-280101	66	0425025-660101
30	0425025-300101	68	0425025-680101
32	0425025-320101	70	0425025-700101
34	0425025-340101	72	0425025-720101
36	0425025-360101	74	0425025-740101
38	0425025-380101	76	0425025-760101
40	0425025-400101	78	0425025-780101
		80	0425025-800101

2.54mm(0.10") Pitch
Pin Header Connector

0425026

Right Angle, SMT

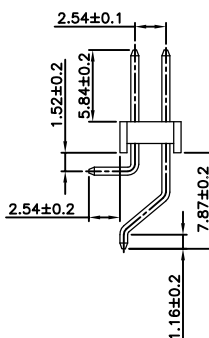
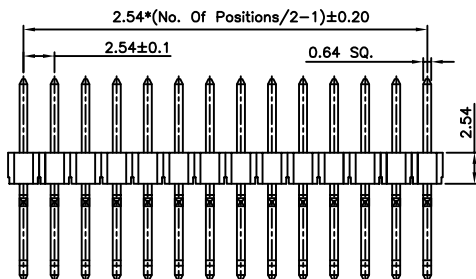
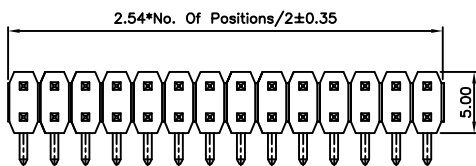

Specifications

Rating

Current Rating:3.0 Amp
Voltage Rating:250V AC/DC
Operating Temperature Range:-40°~+105°C

Electrical

Contact resistance:20m Ohm Max
Insulator resistance:1000M ohm min.
Withstanding Voltage:500V AC/Minute

Material And Finish

Insulator:Nylon 6T UL94V-0 Color:Black
Contact:Brass
Plated:Gold Flash Over Nickel

No.of CKTS	Part No.	No.of CKTS	Part No.
04	0425026-040101	42	0425026-420101
06	0425026-060101	44	0425026-440101
08	0425026-080101	46	0425026-460101
10	0425026-100101	48	0425026-480101
12	0425026-120101	50	0425026-500101
14	0425026-140101	52	0425026-520101
16	0425026-160101	54	0425026-540101
18	0425026-180101	56	0425026-560101
20	0425026-200101	58	0425026-580101
22	0425026-220101	60	0425026-600101
24	0425026-240101	62	0425026-620101
26	0425026-260101	64	0425026-640101
28	0425026-280101	66	0425026-660101
30	0425026-300101	68	0425026-680101
32	0425026-320101	70	0425026-700101
34	0425026-340101	72	0425026-720101
36	0425026-360101	74	0425026-740101
38	0425026-380101	76	0425026-760101
40	0425026-400101	78	0425026-780101
		80	0425026-800101

2.54mm(0.10") Pitch
Pin Header Connector

0425031

Vertical, Through Hole

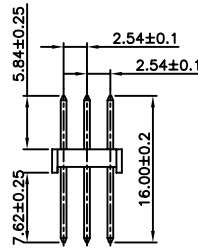
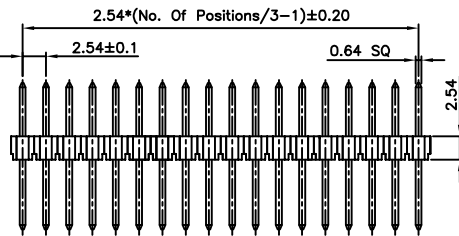
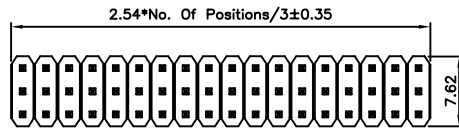

Specifications

Rating

Current Rating:3.0 Amp

Voltage Rating:250V AC/DC

Operating Temperature Range:-40°~+105°C

Electrical

Contact resistance:20m Ohm Max

Insulator resistance:1000M ohm min.

Withstanding Voltage:500V AC/Minute

Material And Finish

Insulator:Nylon 6T UL94V-0 Color:Black

Contact:Brass

Plated:Gold Flash Over Nickel

No.of CKTS	Part No.	No.of CKTS	Part No.
		63	0425031-630100
		66	0425031-660100
09	0425031-090100	69	0425031-690100
12	0425031-120100	72	0425031-720100
15	0425031-150100	75	0425031-750100
18	0425031-180100	78	0425031-780100
21	0425031-210100	81	0425031-810100
24	0425031-240100	84	0425031-840100
27	0425031-270100	87	0425031-870100
30	0425031-300100	90	0425031-900100
33	0425031-330100	93	0425031-930100
36	0425031-360100	96	0425031-960100
39	0425031-390100	99	0425031-990100
42	0425031-420100	102	0425031-1020100
45	0425031-450100	105	0425031-1050100
48	0425031-480100	108	0425031-1080100
51	0425031-510100	111	0425031-1110100
54	0425031-540100	114	0425031-1140100
57	0425031-570100	117	0425031-1170100
60	0425031-600100	120	0425031-1200100

2.54mm(0.10") Pitch
Pin Header Connector

04250312

Vertical, Through Hole

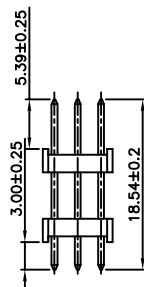
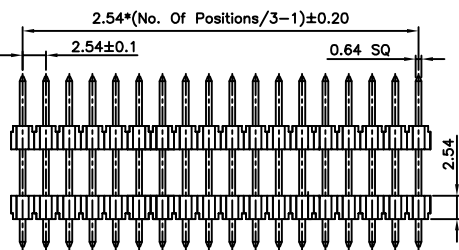
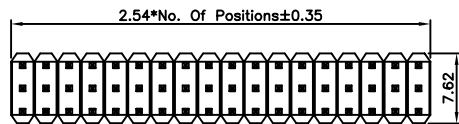

Specifications

Rating

Current Rating:3.0 Amp

Voltage Rating:250V AC/DC

Operating Temperature Range:-40°~+105°C

Electrical

Contact resistance:20m Ohm Max

Insulator resistance:1000M ohm min.

Withstanding Voltage:500V AC/Minute

Material And Finish

Insulator:Nylon 6T UL94V-0 Color:Black

Contact:Brass

Plated:Gold Flash Over Nickel

No.of CKTS	Part No.	No.of CKTS	Part No.
		63	04250312-630100
		66	04250312-660100
09	04250312-090100	69	04250312-690100
12	04250312-120100	72	04250312-720100
15	04250312-150100	75	04250312-750100
18	04250312-180100	78	04250312-780100
21	04250312-210100	81	04250312-810100
24	04250312-240100	84	04250312-840100
27	04250312-270100	87	04250312-870100
30	04250312-300100	90	04250312-900100
33	04250312-330100	93	04250312-930100
36	04250312-360100	96	04250312-960100
39	04250312-390100	99	04250312-990100
42	04250312-420100	102	04250312-1020100
45	04250312-450100	105	04250312-1050100
48	04250312-480100	108	04250312-1080100
51	04250312-510100	111	04250312-1110100
54	04250312-540100	114	04250312-1140100
57	04250312-570100	117	04250312-1170100
60	04250312-600100	120	04250312-1200100

2.54mm(0.10") Pitch
Pin Header Connector

0425032

Right Angle, Through Hole

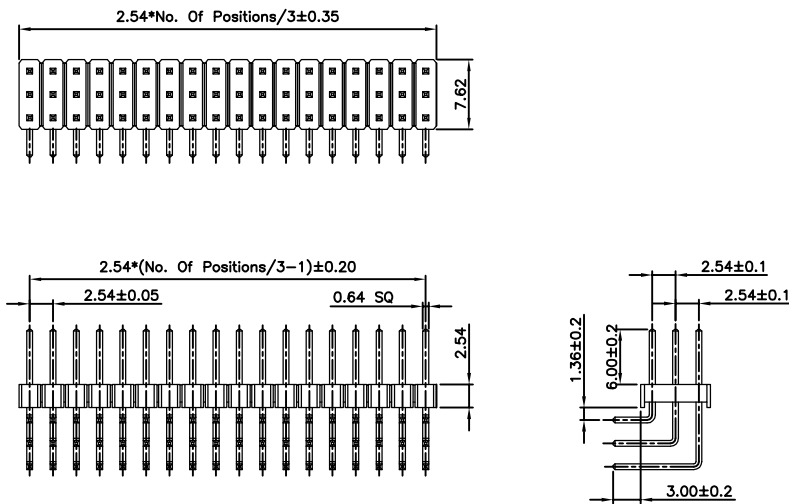

Specifications

Rating

Current Rating:3.0 Amp

Voltage Rating:250V AC/DC

Operating Temperature Range:-40°~+105°C

Electrical

Contact resistance:20m Ohm Max

Insulator resistance:1000M ohm min.

Withstanding Voltage:500V AC/Minute

Material And Finish

Insulator:Nylon 6T UL94V-0 Color:Black

Contact:Brass

Plated:Gold Flash Over Nickel

No.of CKTS	Part No.	No.of CKTS	Part No.
		63	0425032-630100
		66	0425032-660100
09	0425032-090100	69	0425032-690100
12	0425032-120100	72	0425032-720100
15	0425032-150100	75	0425032-750100
18	0425032-180100	78	0425032-780100
21	0425032-210100	81	0425032-810100
24	0425032-240100	84	0425032-840100
27	0425032-270100	87	0425032-870100
30	0425032-300100	90	0425032-900100
33	0425032-330100	93	0425032-930100
36	0425032-360100	96	0425032-960100
39	0425032-390100	99	0425032-990100
42	0425032-420100	102	0425032-1020100
45	0425032-450100	105	0425032-1050100
48	0425032-480100	108	0425032-1080100
51	0425032-510100	111	0425032-1110100
54	0425032-540100	114	0425032-1140100
57	0425032-570100	117	0425032-1170100
60	0425032-600100	120	0425032-1200100

2.54mm(0.10") Pitch
Pin Header Connector

04250322

Right Angle, Through Hole

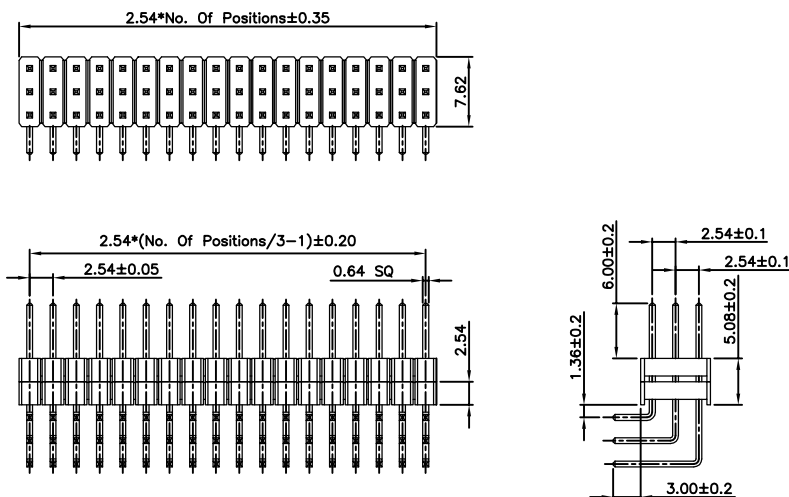

Specifications

Rating

Current Rating:3.0 Amp

Voltage Rating:250V AC/DC

Operating Temperature Range:-40°~+105°C

Electrical

Contact resistance:20m Ohm Max

Insulator resistance:1000M ohm min.

Withstanding Voltage:500V AC/Minute

Material And Finish

Insulator:Nylon 6T UL94V-0 Color:Black

Contact:Brass

Plated:Gold Flash Over Nickel

No.of CKTS	Part No.	No.of CKTS	Part No.
		63	04250322-630100
		66	04250322-660100
09	04250322-090100	69	04250322-690100
12	04250322-120100	72	04250322-720100
15	04250322-150100	75	04250322-750100
18	04250322-180100	78	04250322-780100
21	04250322-210100	81	04250322-810100
24	04250322-240100	84	04250322-840100
27	04250322-270100	87	04250322-870100
30	04250322-300100	90	04250322-900100
33	04250322-330100	93	04250322-930100
36	04250322-360100	96	04250322-960100
39	04250322-390100	99	04250322-990100
42	04250322-420100	102	04250322-1020100
45	04250322-450100	105	04250322-1050100
48	04250322-480100	108	04250322-1080100
51	04250322-510100	111	04250322-1110100
54	04250322-540100	114	04250322-1140100
57	04250322-570100	117	04250322-1170100
60	04250322-600100	120	04250322-1200100

2.54mm(0.10") Pitch
Pin Header Connector

0425042

Right Angle, Through Hole

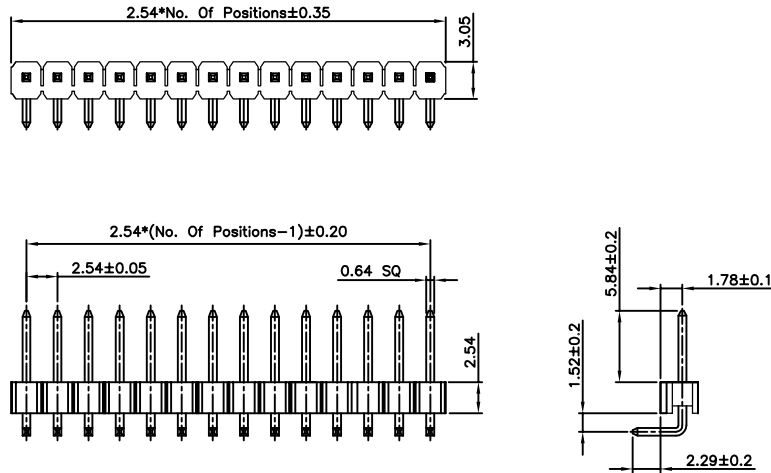

Specifications

Rating

Current Rating:3.0 Amp
Voltage Rating:250V AC/DC
Operating Temperature Range:-40°~+105°C

Electrical

Contact resistance:20m Ohm Max
Insulator resistance:1000M ohm min.
Withstanding Voltage:500V AC/Minute

Material And Finish

Insulator:Nylon 6T UL94V-0 Color:Black
Contact:Brass
Plated:Gold Flash Over Nickel

No.of CKTS	Part No.	No.of CKTS	Part No.
01	0425042-010100	21	0425042-210100
02	0425042-020100	22	0425042-220100
03	0425042-030100	23	0425042-230100
04	0425042-040100	24	0425042-240100
05	0425042-050100	25	0425042-250100
06	0425042-060100	26	0425042-260100
07	0425042-070100	27	0425042-270100
08	0425042-080100	28	0425042-280100
09	0425042-090100	29	0425042-290100
10	0425042-100100	30	0425042-300100
11	0425042-110100	31	0425042-310100
12	0425042-120100	32	0425042-320100
13	0425042-130100	33	0425042-330100
14	0425042-140100	34	0425042-340100
15	0425042-150100	35	0425042-350100
16	0425042-160100	36	0425042-360100
17	0425042-170100	37	0425042-370100
18	0425042-180100	38	0425042-380100
19	0425042-190100	39	0425042-390100
20	0425042-200100	40	0425042-400100

2.54mm(0.10") Pitch
Pin Header Connector

0425045

Right Angle, SMT

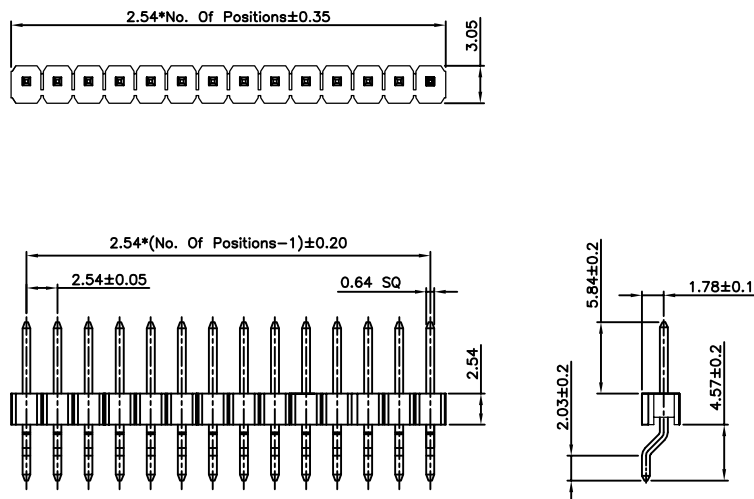

Specifications

Rating

Current Rating:3.0 Amp
Voltage Rating:250V AC/DC
Operating Temperature Range:-40°~+105°C

Electrical

Contact resistance:20m Ohm Max
Insulator resistance:1000M ohm min.
Withstanding Voltage:500V AC/Minute

Material And Finish

Insulator:Nylon 6T UL94V-0 Color:Black
Contact:Brass
Plated:Gold Flash Over Nickel

No.of CKTS	Part No.	No.of CKTS	Part No.
02	0425045-020101	21	0425045-210101
03	0425045-030101	22	0425045-220101
04	0425045-040101	23	0425045-230101
05	0425045-050101	24	0425045-240101
06	0425045-060101	25	0425045-250101
07	0425045-070101	26	0425045-260101
08	0425045-080101	27	0425045-270101
09	0425045-090101	28	0425045-280101
10	0425045-100101	29	0425045-290101
11	0425045-110101	30	0425045-300101
12	0425045-120101	31	0425045-310101
13	0425045-130101	32	0425045-320101
14	0425045-140101	33	0425045-330101
15	0425045-150101	34	0425045-340101
16	0425045-160101	35	0425045-350101
17	0425045-170101	36	0425045-360101
18	0425045-180101	37	0425045-370101
19	0425045-190101	38	0425045-380101
20	0425045-200101	39	0425045-390101
		40	0425045-400101

2.54mm(0.10") Pitch
Pin Header Connector

0425082

Right Angle, Through Hole

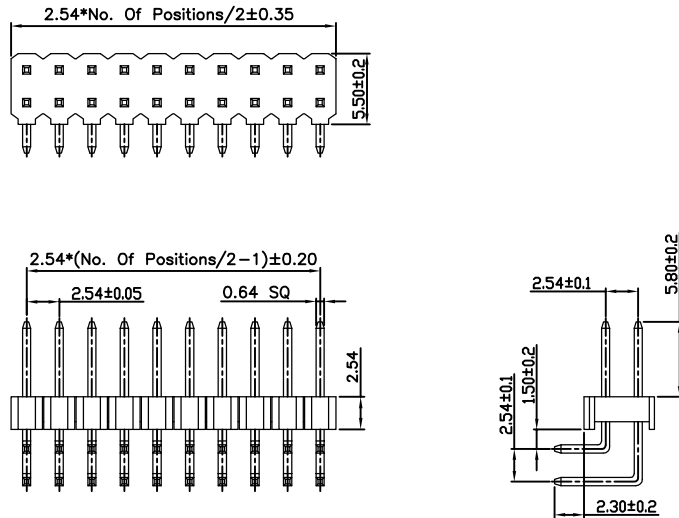

Specifications

Rating

Current Rating:3.0 Amp
Voltage Rating:250V AC/DC
Operating Temperature Range:-40°~+105°C

Electrical

Contact resistance:20m Ohm Max
Insulator resistance:1000M ohm min.
Withstanding Voltage:500V AC/Minute

Material And Finish

Insulator:Nylon 6T UL94V-0 Color:Black
Contact:Brass
Plated:Gold Flash Over Nickel

No.of CKTS	Part No.	No.of CKTS	Part No.
04	0425082-040100	42	0425082-420100
06	0425082-060100	44	0425082-440100
08	0425082-080100	46	0425082-460100
10	0425082-100100	48	0425082-480100
12	0425082-120100	50	0425082-500100
14	0425082-140100	52	0425082-520100
16	0425082-160100	54	0425082-540100
18	0425082-180100	56	0425082-560100
20	0425082-200100	58	0425082-580100
22	0425082-220100	60	0425082-600100
24	0425082-240100	62	0425082-620100
26	0425082-260100	64	0425082-640100
28	0425082-280100	66	0425082-660100
30	0425082-300100	68	0425082-680100
32	0425082-320100	70	0425082-700100
34	0425082-340100	72	0425082-720100
36	0425082-360100	74	0425082-740100
38	0425082-380100	76	0425082-760100
40	0425082-400100	78	0425082-780100
		80	0425082-800100

2.54mm(0.10") Pitch
Pin Header Connector

0425085

Right Angle, SMT

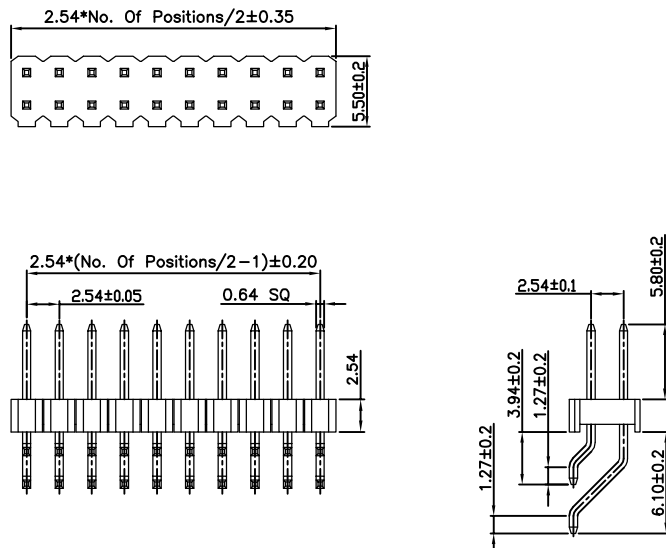

Specifications

Rating

Current Rating:3.0 Amp
Voltage Rating:250V AC/DC
Operating Temperature Range:-40°~+105°C

Electrical

Contact resistance:20m Ohm Max
Insulator resistance:1000M ohm min.
Withstanding Voltage:500V AC/Minute

Material And Finish

Insulator:Nylon 6T UL94V-0 Color:Black
Contact:Brass
Plated:Gold Flash Over Nickel

No.of CKTS	Part No.	No.of CKTS	Part No.
04	0425085-040101	42	0425085-420101
06	0425085-060101	44	0425085-440101
08	0425085-080101	46	0425085-460101
10	0425085-100101	48	0425085-480101
12	0425085-120101	50	0425085-500101
14	0425085-140101	52	0425085-520101
16	0425085-160101	54	0425085-540101
18	0425085-180101	56	0425085-560101
20	0425085-200101	58	0425085-580101
22	0425085-220101	60	0425085-600101
24	0425085-240101	62	0425085-620101
26	0425085-260101	64	0425085-640101
28	0425085-280101	66	0425085-660101
30	0425085-300101	68	0425085-680101
32	0425085-320101	70	0425085-700101
34	0425085-340101	72	0425085-720101
36	0425085-360101	74	0425085-740101
38	0425085-380101	76	0425085-760101
40	0425085-400101	78	0425085-780101
		80	0425085-800101

2.54mm(0.10") Pitch
Pin Header Connector

0425051

Vertical, Through Hole

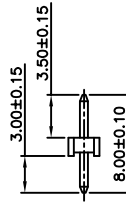
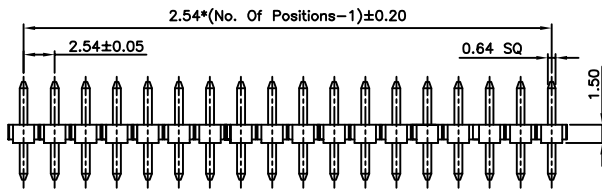
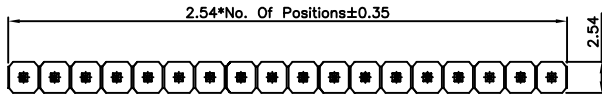

Specifications

Rating

Current Rating:3.0 Amp
Voltage Rating:250V AC/DC
Operating Temperature Range:-40°~+105°C

Electrical

Contact resistance:20m Ohm Max
Insulator resistance:1000M ohm min.
Withstanding Voltage:500V AC/Minute

Material And Finish

Insulator:Nylon 6T UL94V-0 Color:Black
Contact:Brass
Plated:Gold Flash Over Nickel

No.of CKTS	Part No.	No.of CKTS	Part No.
01	0425051-010100	21	0425051-210100
02	0425051-020100	22	0425051-220100
03	0425051-030100	23	0425051-230100
04	0425051-040100	24	0425051-240100
05	0425051-050100	25	0425051-250100
06	0425051-060100	26	0425051-260100
07	0425051-070100	27	0425051-270100
08	0425051-080100	28	0425051-280100
09	0425051-090100	29	0425051-290100
10	0425051-100100	30	0425051-300100
11	0425051-110100	31	0425051-310100
12	0425051-120100	32	0425051-320100
13	0425051-130100	33	0425051-330100
14	0425051-140100	34	0425051-340100
15	0425051-150100	35	0425051-350100
16	0425051-160100	36	0425051-360100
17	0425051-170100	37	0425051-370100
18	0425051-180100	38	0425051-380100
19	0425051-190100	39	0425051-390100
20	0425051-200100	40	0425051-400100

2.54mm(0.10") Pitch
Pin Header Connector

04250512

Vertical, Through Hole

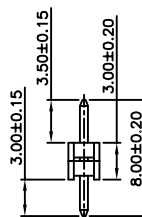
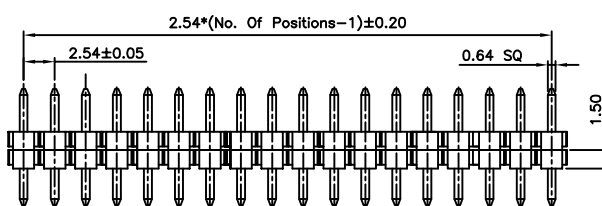
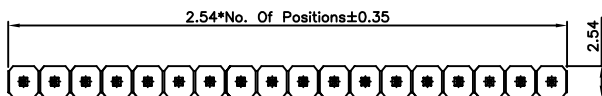

Specifications

Rating

Current Rating:3.0 Amp
Voltage Rating:250V AC/DC
Operating Temperature Range:-40°~+105°C

Electrical

Contact resistance:20m Ohm Max
Insulator resistance:1000M ohm min.
Withstanding Voltage:500V AC/Minute

Material And Finish

Insulator:Nylon 6T UL94V-0 Color:Black
Contact:Brass
Plated:Gold Flash Over Nickel

No.of CKTS	Part No.	No.of CKTS	Part No.
01	04250512-010100	21	04250512-210100
02	04250512-020100	22	04250512-220100
03	04250512-030100	23	04250512-230100
04	04250512-040100	24	04250512-240100
05	04250512-050100	25	04250512-250100
06	04250512-060100	26	04250512-260100
07	04250512-070100	27	04250512-270100
08	04250512-080100	28	04250512-280100
09	04250512-090100	29	04250512-290100
10	04250512-100100	30	04250512-300100
11	04250512-110100	31	04250512-310100
12	04250512-120100	32	04250512-320100
13	04250512-130100	33	04250512-330100
14	04250512-140100	34	04250512-340100
15	04250512-150100	35	04250512-350100
16	04250512-160100	36	04250512-360100
17	04250512-170100	37	04250512-370100
18	04250512-180100	38	04250512-380100
19	04250512-190100	39	04250512-390100
20	04250512-200100	40	04250512-400100

2.54mm(0.10") Pitch
Pin Header Connector

0425052

Right Angle, Through Hole

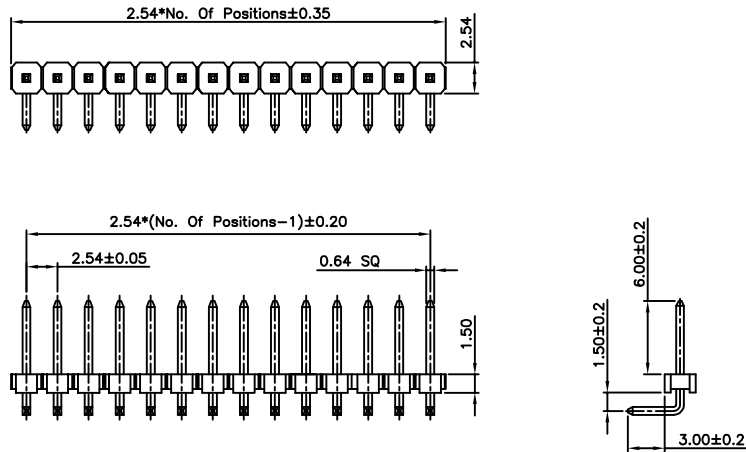

Specifications

Rating

Current Rating:3.0 Amp
Voltage Rating:250V AC/DC
Operating Temperature Range:-40°~+105°C

Electrical

Contact resistance:20m Ohm Max
Insulator resistance:1000M ohm min.
Withstanding Voltage:500V AC/Minute

Material And Finish

Insulator:Nylon 6T UL94V-0 Color:Black
Contact:Brass
Plated:Gold Flash Over Nickel

No.of CKTS	Part No.	No.of CKTS	Part No.
01	0425052-010100	21	0425052-210100
02	0425052-020100	22	0425052-220100
03	0425052-030100	23	0425052-230100
04	0425052-040100	24	0425052-240100
05	0425052-050100	25	0425052-250100
06	0425052-060100	26	0425052-260100
07	0425052-070100	27	0425052-270100
08	0425052-080100	28	0425052-280100
09	0425052-090100	29	0425052-290100
10	0425052-100100	30	0425052-300100
11	0425052-110100	31	0425052-310100
12	0425052-120100	32	0425052-320100
13	0425052-130100	33	0425052-330100
14	0425052-140100	34	0425052-340100
15	0425052-150100	35	0425052-350100
16	0425052-160100	36	0425052-360100
17	0425052-170100	37	0425052-370100
18	0425052-180100	38	0425052-380100
19	0425052-190100	39	0425052-390100
20	0425052-200100	40	0425052-400100

2.54mm(0.10") Pitch
Pin Header Connector

04250522

Right Angle, Through Hole

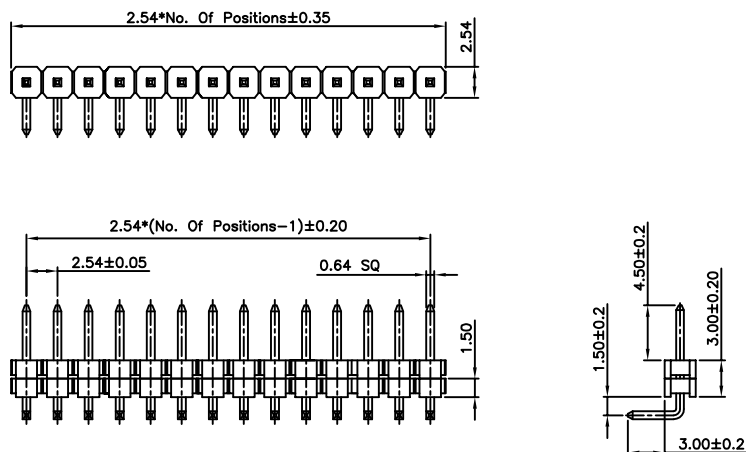

Specifications

Rating

Current Rating:3.0 Amp
Voltage Rating:250V AC/DC
Operating Temperature Range:-40°~+105°C

Electrical

Contact resistance:20m Ohm Max
Insulator resistance:1000M ohm min.
Withstanding Voltage:500V AC/Minute

Material And Finish

Insulator:Nylon 6T UL94V-0 Color:Black
Contact:Brass
Plated:Gold Flash Over Nickel

No.of CKTS	Part No.	No.of CKTS	Part No.
01	04250522-010100	21	04250522-210100
02	04250522-020100	22	04250522-220100
03	04250522-030100	23	04250522-230100
04	04250522-040100	24	04250522-240100
05	04250522-050100	25	04250522-250100
06	04250522-060100	26	04250522-260100
07	04250522-070100	27	04250522-270100
08	04250522-080100	28	04250522-280100
09	04250522-090100	29	04250522-290100
10	04250522-100100	30	04250522-300100
11	04250522-110100	31	04250522-310100
12	04250522-120100	32	04250522-320100
13	04250522-130100	33	04250522-330100
14	04250522-140100	34	04250522-340100
15	04250522-150100	35	04250522-350100
16	04250522-160100	36	04250522-360100
17	04250522-170100	37	04250522-370100
18	04250522-180100	38	04250522-380100
19	04250522-190100	39	04250522-390100
20	04250522-200100	40	04250522-400100

2.54mm(0.10") Pitch
Pin Header Connector

0425053
Vertical, SMT

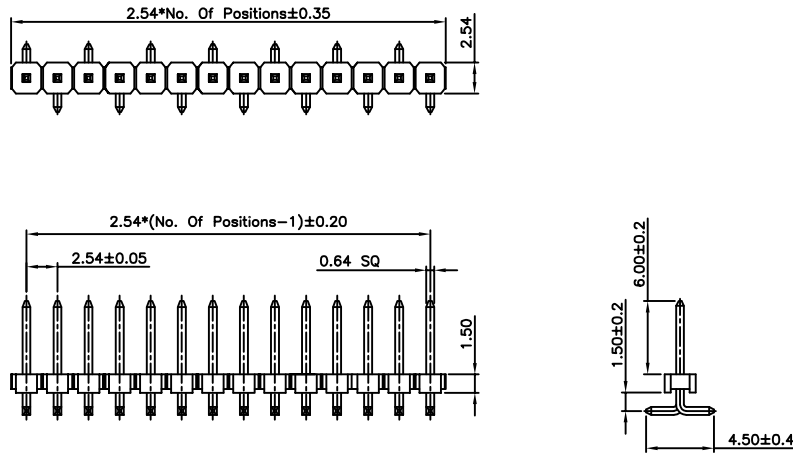

Specifications

Rating

Current Rating:3.0 Amp
Voltage Rating:250V AC/DC
Operating Temperature Range:-40°~+105°C

Electrical

Contact resistance:20m Ohm Max
Insulator resistance:1000M ohm min.
Withstanding Voltage:500V AC/Minute

Material And Finish

Insulator:Nylon 6T UL94V-0 Color:Black
Contact:Brass
Plated:Gold Flash Over Nickel

No.of CKTS	Part No.	No.of CKTS	Part No.
02	0425053-020101	21	0425053-210101
03	0425053-030101	22	0425053-220101
04	0425053-040101	23	0425053-230101
05	0425053-050101	24	0425053-240101
06	0425053-060101	25	0425053-250101
07	0425053-070101	26	0425053-260101
08	0425053-080101	27	0425053-270101
09	0425053-090101	28	0425053-280101
10	0425053-100101	29	0425053-290101
11	0425053-110101	30	0425053-300101
12	0425053-120101	31	0425053-310101
13	0425053-130101	32	0425053-320101
14	0425053-140101	33	0425053-330101
15	0425053-150101	34	0425053-340101
16	0425053-160101	35	0425053-350101
17	0425053-170101	36	0425053-360101
18	0425053-180101	37	0425053-370101
19	0425053-190101	38	0425053-380101
20	0425053-200101	39	0425053-390101
		40	0425053-400101

2.54mm(0.10") Pitch
Pin Header Connector

04250532
Vertical, SMT

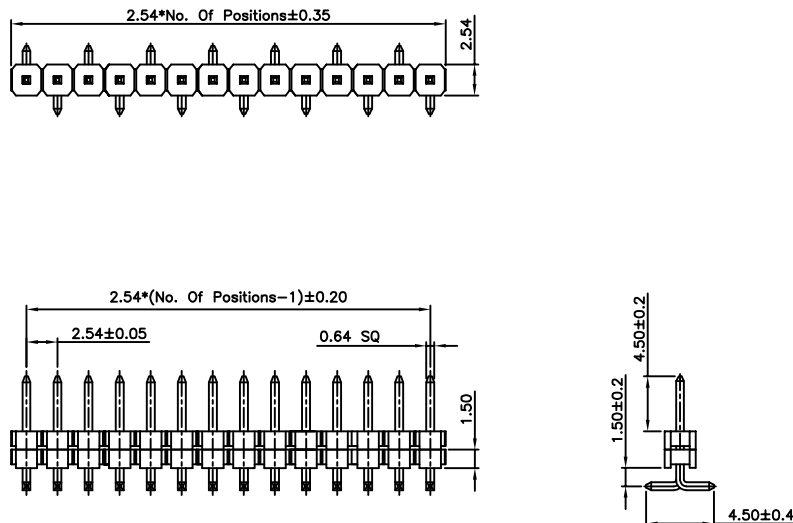

Specifications

Rating

Current Rating:3.0 Amp
Voltage Rating:250V AC/DC
Operating Temperature Range:-40°~+105°C

Electrical

Contact resistance:20m Ohm Max
Insulator resistance:1000M ohm min.
Withstanding Voltage:500V AC/Minute

Material And Finish

Insulator:Nylon 6T UL94V-0 Color:Black
Contact:Brass
Plated:Gold Flash Over Nickel

No.of CKTS	Part No.	No.of CKTS	Part No.
02	04250532-020101	21	04250532-210101
03	04250532-030101	22	04250532-220101
04	04250532-040101	23	04250532-230101
05	04250532-050101	24	04250532-240101
06	04250532-060101	25	04250532-250101
07	04250532-070101	26	04250532-260101
08	04250532-080101	27	04250532-270101
09	04250532-090101	28	04250532-280101
10	04250532-100101	29	04250532-290101
11	04250532-110101	30	04250532-300101
12	04250532-120101	31	04250532-310101
13	04250532-130101	32	04250532-320101
14	04250532-140101	33	04250532-330101
15	04250532-150101	34	04250532-340101
16	04250532-160101	35	04250532-350101
17	04250532-170101	36	04250532-360101
18	04250532-180101	37	04250532-370101
19	04250532-190101	38	04250532-380101
20	04250532-200101	39	04250532-390101
		40	04250532-400101

2.54mm(0.10") Pitch
Pin Header Connector

0425061

Vertical, Through Hole

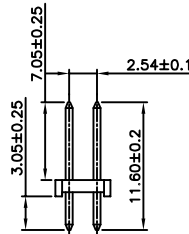
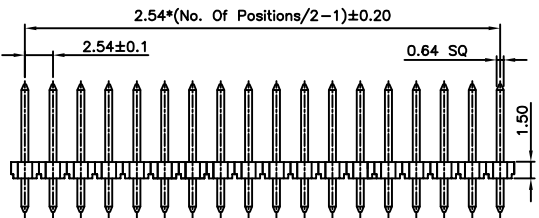
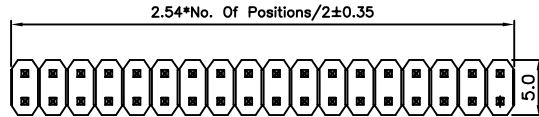

Specifications

Rating

Current Rating:3.0 Amp

Voltage Rating:250V AC/DC

Operating Temperature Range:-40°~+105°C

Electrical

Contact resistance:20m Ohm Max

Insulator resistance:1000M ohm min.

Withstanding Voltage:500V AC/Minute

Material And Finish

Insulator:Nylon 6T UL94V-0 Color:Black

Contact:Brass

Plated:Gold Flash Over Nickel

No.of CKTS	Part No.	No.of CKTS	Part No.
04	0425061-040100	42	0425061-420100
06	0425061-060100	44	0425061-440100
08	0425061-080100	46	0425061-460100
10	0425061-100100	48	0425061-480100
12	0425061-120100	50	0425061-500100
14	0425061-140100	52	0425061-520100
16	0425061-160100	54	0425061-540100
18	0425061-180100	56	0425061-560100
20	0425061-200100	58	0425061-580100
22	0425061-220100	60	0425061-600100
24	0425061-240100	62	0425061-620100
26	0425061-260100	64	0425061-640100
28	0425061-280100	66	0425061-660100
30	0425061-300100	68	0425061-680100
32	0425061-320100	70	0425061-700100
34	0425061-340100	72	0425061-720100
36	0425061-360100	74	0425061-740100
38	0425061-380100	76	0425061-760100
40	0425061-400100	78	0425061-780100
		80	0425061-800100

2.54mm(0.10") Pitch
Pin Header Connector

04250612

Vertical, Through Hole

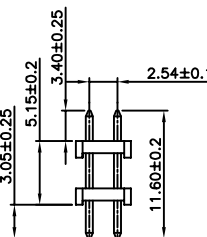
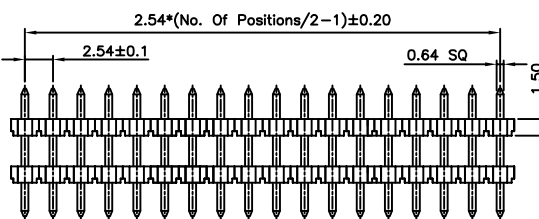
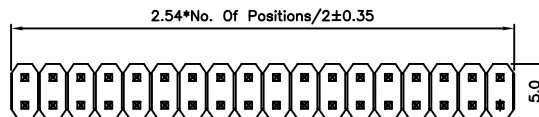

Specifications

Rating

Current Rating:3.0 Amp

Voltage Rating:250V AC/DC

Operating Temperature Range:-40°~+105°C

Electrical

Contact resistance:20m Ohm Max

Insulator resistance:1000M ohm min.

Withstanding Voltage:500V AC/Minute

Material And Finish

Insulator:Nylon 6T UL94V-0 Color:Black

Contact:Brass

Plated:Gold Flash Over Nickel

No.of CKTS	Part No.	No.of CKTS	Part No.
04	04250612-040100	42	04250612-420100
06	04250612-060100	44	04250612-440100
08	04250612-080100	46	04250612-460100
10	04250612-100100	48	04250612-480100
12	04250612-120100	50	04250612-500100
14	04250612-140100	52	04250612-520100
16	04250612-160100	54	04250612-540100
18	04250612-180100	56	04250612-560100
20	04250612-200100	58	04250612-580100
22	04250612-220100	60	04250612-600100
24	04250612-240100	62	04250612-620100
26	04250612-260100	64	04250612-640100
28	04250612-280100	66	04250612-660100
30	04250612-300100	68	04250612-680100
32	04250612-320100	70	04250612-700100
34	04250612-340100	72	04250612-720100
36	04250612-360100	74	04250612-740100
38	04250612-380100	76	04250612-760100
40	04250612-400100	78	04250612-780100
		80	04250612-800100

2.54mm(0.10") Pitch
Pin Header Connector

0425062

Right Angle, Through Hole

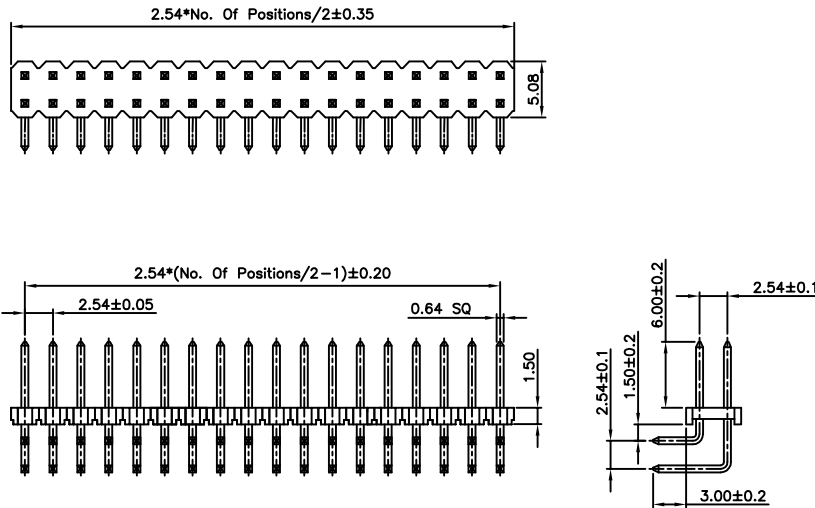

Specifications

Rating

Current Rating:3.0 Amp
Voltage Rating:250V AC/DC
Operating Temperature Range:-40°~+105°C

Electrical

Contact resistance:20m Ohm Max
Insulator resistance:1000M ohm min.
Withstanding Voltage:500V AC/Minute

Material And Finish

Insulator:Nylon 6T UL94V-0 Color:Black
Contact:Brass
Plated:Gold Flash Over Nickel

No.of CKTS	Part No.	No.of CKTS	Part No.
04	0425062-040100	42	0425062-420100
06	0425062-060100	44	0425062-440100
08	0425062-080100	46	0425062-460100
10	0425062-100100	48	0425062-480100
12	0425062-120100	50	0425062-500100
14	0425062-140100	52	0425062-520100
16	0425062-160100	54	0425062-540100
18	0425062-180100	56	0425062-560100
20	0425062-200100	58	0425062-580100
22	0425062-220100	60	0425062-600100
24	0425062-240100	62	0425062-620100
26	0425062-260100	64	0425062-640100
28	0425062-280100	66	0425062-660100
30	0425062-300100	68	0425062-680100
32	0425062-320100	70	0425062-700100
34	0425062-340100	72	0425062-720100
36	0425062-360100	74	0425062-740100
38	0425062-380100	76	0425062-760100
40	0425062-400100	78	0425062-780100
		80	0425062-800100

2.54mm(0.10") Pitch
Pin Header Connector

04250622

Right Angle, Through Hole

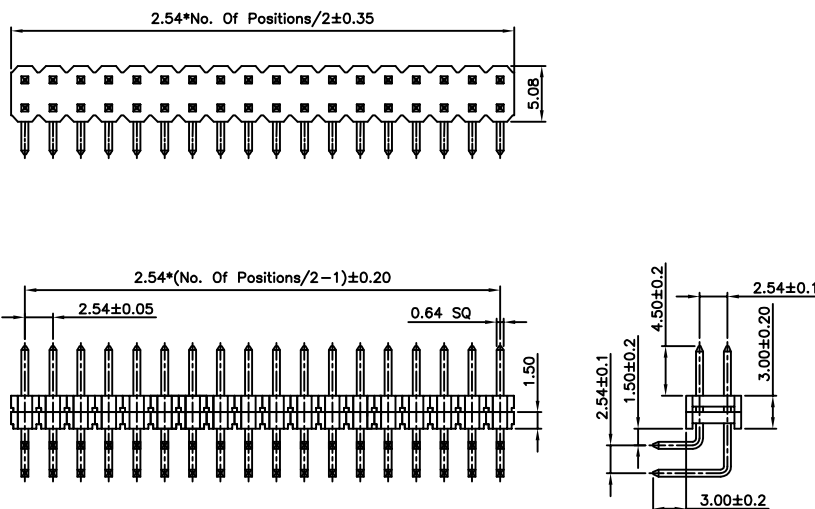

Specifications

Rating

Current Rating:3.0 Amp
Voltage Rating:250V AC/DC
Operating Temperature Range:-40°~+105°C

Electrical

Contact resistance:20m Ohm Max
Insulator resistance:1000M ohm min.
Withstanding Voltage:500V AC/Minute

Material And Finish

Insulator:Nylon 6T UL94V-0 Color:Black
Contact:Brass
Plated:Gold Flash Over Nickel

No.of CKTS	Part No.	No.of CKTS	Part No.
04	04250622-040100	42	04250622-420100
06	04250622-060100	44	04250622-440100
08	04250622-080100	46	04250622-460100
10	04250622-100100	48	04250622-480100
12	04250622-120100	50	04250622-500100
14	04250622-140100	52	04250622-520100
16	04250622-160100	54	04250622-540100
18	04250622-180100	56	04250622-560100
20	04250622-200100	58	04250622-580100
22	04250622-220100	60	04250622-600100
24	04250622-240100	62	04250622-620100
26	04250622-260100	64	04250622-640100
28	04250622-280100	66	04250622-660100
30	04250622-300100	68	04250622-680100
32	04250622-320100	70	04250622-700100
34	04250622-340100	72	04250622-720100
36	04250622-360100	74	04250622-740100
38	04250622-380100	76	04250622-760100
40	04250622-400100	78	04250622-780100
		80	04250622-800100

2.54mm(0.10") Pitch
Pin Header Connector

0425063
Vertical, SMT

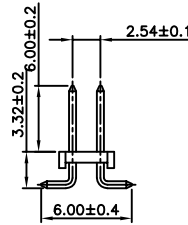
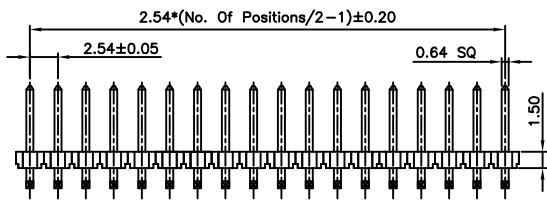
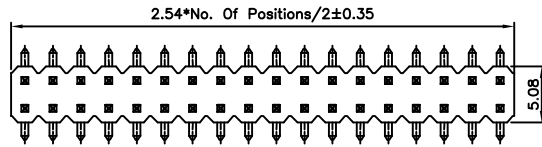

Specifications

Rating

Current Rating:3.0 Amp
Voltage Rating:250V AC/DC
Operating Temperature Range:-40°~+105°C

Electrical

Contact resistance:20m Ohm Max
Insulator resistance:1000M ohm min.
Withstanding Voltage:500V AC/Minute

Material And Finish

Insulator:Nylon 6T UL94V-0 Color:Black
Contact:Brass
Plated:Gold Flash Over Nickel

No.of CKTS	Part No.	No.of CKTS	Part No.
04	0425063-040101	42	0425063-420101
06	0425063-060101	44	0425063-440101
08	0425063-080101	46	0425063-460101
10	0425063-100101	48	0425063-480101
12	0425063-120101	50	0425063-500101
14	0425063-140101	52	0425063-520101
16	0425063-160101	54	0425063-540101
18	0425063-180101	56	0425063-560101
20	0425063-200101	58	0425063-580101
22	0425063-220101	60	0425063-600101
24	0425063-240101	62	0425063-620101
26	0425063-260101	64	0425063-640101
28	0425063-280101	66	0425063-660101
30	0425063-300101	68	0425063-680101
32	0425063-320101	70	0425063-700101
34	0425063-340101	72	0425063-720101
36	0425063-360101	74	0425063-740101
38	0425063-380101	76	0425063-760101
40	0425063-400101	78	0425063-780101
		80	0425063-800101

2.54mm(0.10") Pitch
Pin Header Connector

04250632
Vertical, SMT

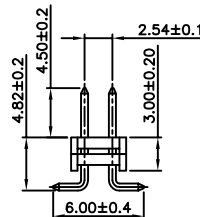
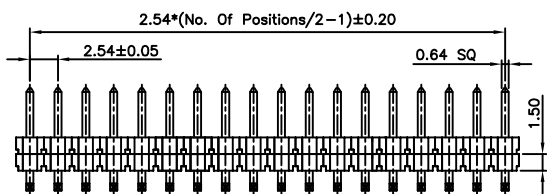
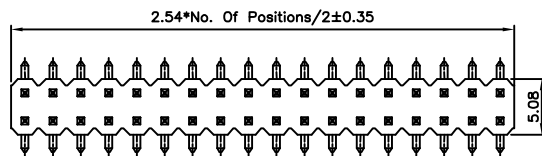

Specifications

Rating

Current Rating:3.0 Amp
Voltage Rating:250V AC/DC
Operating Temperature Range:-40°~+105°C

Electrical

Contact resistance:20m Ohm Max
Insulator resistance:1000M ohm min.
Withstanding Voltage:500V AC/Minute

Material And Finish

Insulator:Nylon 6T UL94V-0 Color:Black
Contact:Brass
Plated:Gold Flash Over Nickel

No.of CKTS	Part No.	No.of CKTS	Part No.
04	04250632-040101	42	04250632-420101
06	04250632-060101	44	04250632-440101
08	04250632-080101	46	04250632-460101
10	04250632-100101	48	04250632-480101
12	04250632-120101	50	04250632-500101
14	04250632-140101	52	04250632-520101
16	04250632-160101	54	04250632-540101
18	04250632-180101	56	04250632-560101
20	04250632-200101	58	04250632-580101
22	04250632-220101	60	04250632-600101
24	04250632-240101	62	04250632-620101
26	04250632-260101	64	04250632-640101
28	04250632-280101	66	04250632-660101
30	04250632-300101	68	04250632-680101
32	04250632-320101	70	04250632-700101
34	04250632-340101	72	04250632-720101
36	04250632-360101	74	04250632-740101
38	04250632-380101	76	04250632-760101
40	04250632-400101	78	04250632-780101
		80	04250632-800101

2.54mm(0.10") Pitch
Pin Header Connector

0425071

Vertical, Through Hole

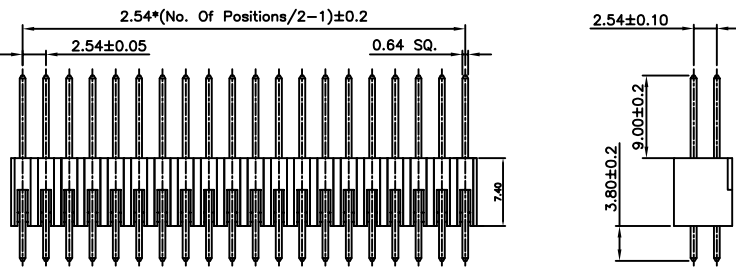
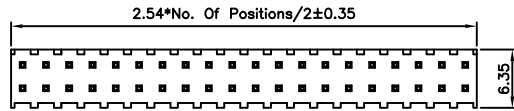

Specifications

Rating

Current Rating:3.0 Amp
Voltage Rating:250V AC/DC
Operating Temperature Range:-40°~+105°C

Electrical

Contact resistance:20m Ohm Max
Insulator resistance:1000M ohm min.
Withstanding Voltage:500V AC/Minute

Material And Finish

Insulator:PBT UL94V-0 Color:Black
Contact:Brass
Plated:Gold Flash Over Nickel

No.of CKTS	Part No.	No.of CKTS	Part No.
04	0425071-040000	42	0425071-420000
06	0425071-060000	44	0425071-440000
08	0425071-080000	46	0425071-460000
10	0425071-100000	48	0425071-480000
12	0425071-120000	50	0425071-500000
14	0425071-140000	52	0425071-520000
16	0425071-160000	54	0425071-540000
18	0425071-180000	56	0425071-560000
20	0425071-200000	58	0425071-580000
22	0425071-220000	60	0425071-600000
24	0425071-240000	62	0425071-620000
26	0425071-260000	64	0425071-640000
28	0425071-280000	66	0425071-660000
30	0425071-300000	68	0425071-680000
32	0425071-320000	70	0425071-700000
34	0425071-340000	72	0425071-720000
36	0425071-360000	74	0425071-740000
38	0425071-380000	76	0425071-760000
40	0425071-400000	78	0425071-780000
		80	0425071-800000

2.54mm(0.10") Pitch
Pin Header Connector

0425072

Right Angle, Through Hole

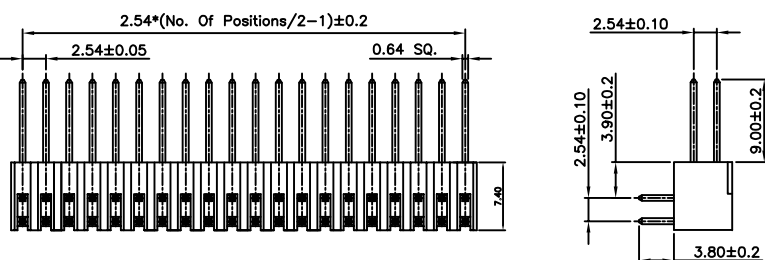
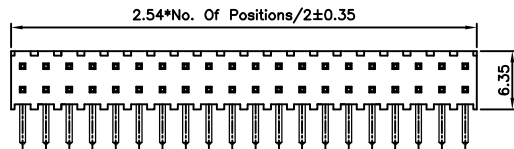

Specifications

Rating

Current Rating:3.0 Amp
Voltage Rating:250V AC/DC
Operating Temperature Range:-40°~+105°C

Electrical

Contact resistance:20m Ohm Max
Insulator resistance:1000M ohm min.
Withstanding Voltage:500V AC/Minute

Material And Finish

Insulator:PBT UL94V-0 Color:Black
Contact:Brass
Plated:Gold Flash Over Nickel

No.of CKTS	Part No.	No.of CKTS	Part No.
04	0425072-040000	42	0425072-420000
06	0425072-060000	44	0425072-440000
08	0425072-080000	46	0425072-460000
10	0425072-100000	48	0425072-480000
12	0425072-120000	50	0425072-500000
14	0425072-140000	52	0425072-520000
16	0425072-160000	54	0425072-540000
18	0425072-180000	56	0425072-560000
20	0425072-200000	58	0425072-580000
22	0425072-220000	60	0425072-600000
24	0425072-240000	62	0425072-620000
26	0425072-260000	64	0425072-640000
28	0425072-280000	66	0425072-660000
30	0425072-300000	68	0425072-680000
32	0425072-320000	70	0425072-700000
34	0425072-340000	72	0425072-720000
36	0425072-360000	74	0425072-740000
38	0425072-380000	76	0425072-760000
40	0425072-400000	78	0425072-780000
		80	0425072-800000