

**Universal Serial Bus (USB)
I/O Connectors
Type 'A' Plug**

0600012

Right Angle, Through Hole

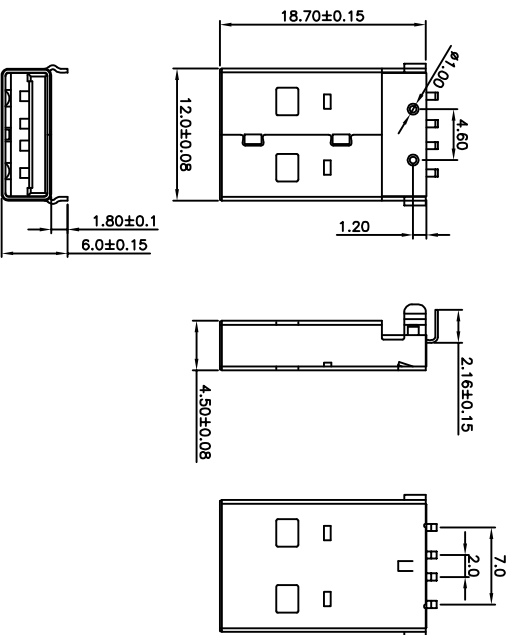

Specifications
Rating
 Current Rating:1.5 Amp Max.
 Voltage Rating:150V AC/DC Max.
 Operating Temperature Range:-25~+85°C

Electrical
 Contact resistance:30m Ohm Max
 Insulator resistance:1000M ohm min.
 Withstanding Voltage:500V AC/Minute

Material And Finish
 Insulator:PBT UL94V-0 Color:Black
 Contact:Copper Alloy
 Plated:Gold Flash; Soldertail:Tin.
 Shell:Copper Alloy With Nickel Plate

No.of CKTS	Part No.
04	0600012-041002

**Universal Serial Bus (USB)
I/O Connectors
Type 'A' Plug**

0600024

Right Angle, SMT

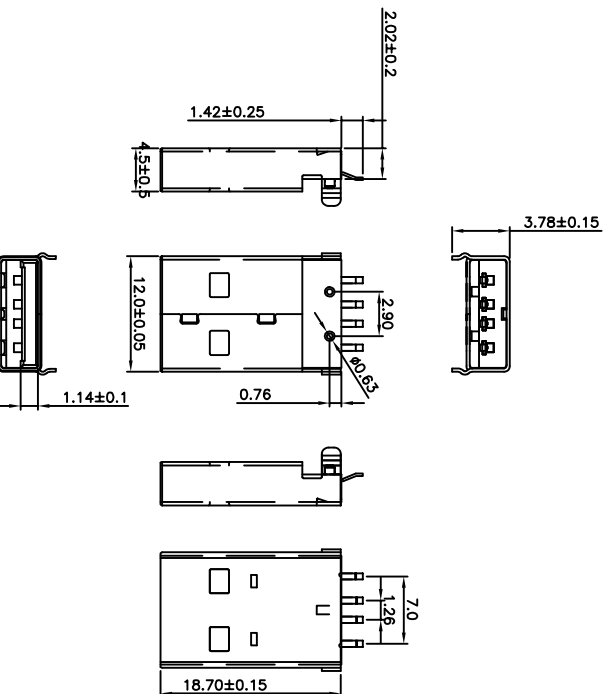

Specifications
Rating
 Current Rating:1.5 Amp Max.
 Voltage Rating:150V AC/DC Max.
 Operating Temperature Range:-25~+85°C

Electrical
 Contact resistance:30m Ohm Max
 Insulator resistance:1000M ohm min.
 Withstanding Voltage:500V AC/Minute

Material And Finish
 Insulator:Nylon 6T UL94V-0 Color:Black
 Contact:Copper Alloy
 Plated:Gold Flash; Soldertail:Tin.
 Shell:Copper Alloy With Nickel Plate

No.of CKTS	Part No.
04	0600024-041102

**Universal Serial Bus (USB)
I/O Connectors
Type 'A' Female**

0600031

Vertical, Through Hole

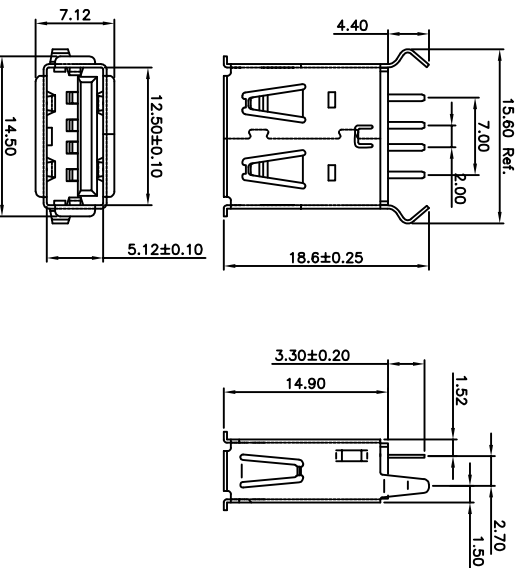

No. of CKTS	Part No.
04	0600031-041002

Specifications

Rating

Current Rating:1.5 Amp Max.
Voltage Rating:150V AC/DC Max.
Operating Temperature Range:-25°~+85°C

Electrical

Contact resistance:30m Ohm Max
Insulator resistance:1000M ohm min.
Withstanding Voltage:500V AC/Minute

Material And Finish

Insulator:PBT UL94V-0 Color:Black
Contact:Copper Alloy
Plated:Gold Flash; Solder tail:Ti.
Shell:Copper Alloy With Nickel Plate

**Universal Serial Bus (USB)
I/O Connectors
Type 'A' Plug**

0600032

Right Angle, Through Hole

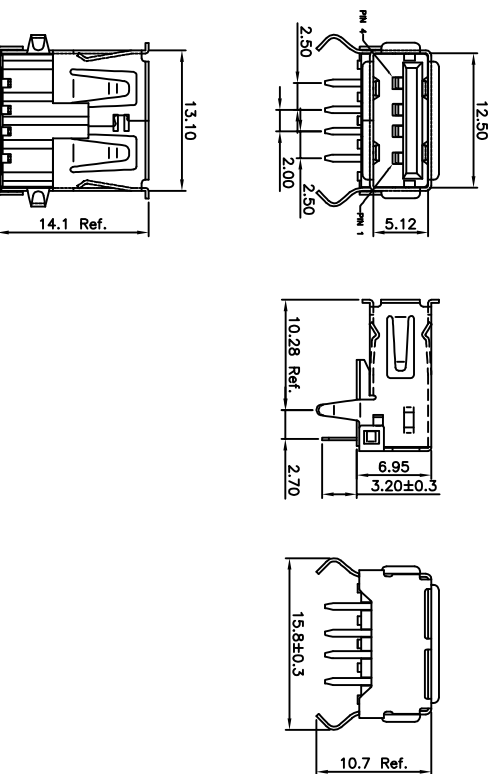

No. of CKTS	Part No.
04	0600032-041002

Specifications

Rating

Current Rating:1.5 Amp Max.
Voltage Rating:150V AC/DC Max.
Operating Temperature Range:-25°~+85°C

Electrical

Contact resistance:30m Ohm Max
Insulator resistance:1000M ohm min.
Withstanding Voltage:500V AC/Minute

Material And Finish

Insulator:Nylon 6T UL94V-0 Color:Black
Contact:Copper Alloy
Plated:Gold Flash; Solder tail:Ti.
Shell:Copper Alloy With Nickel Plate

**Universal Serial Bus (USB)
I/O Connectors
Type 'A' Female**

0600035

Upright Angle, Through Hole

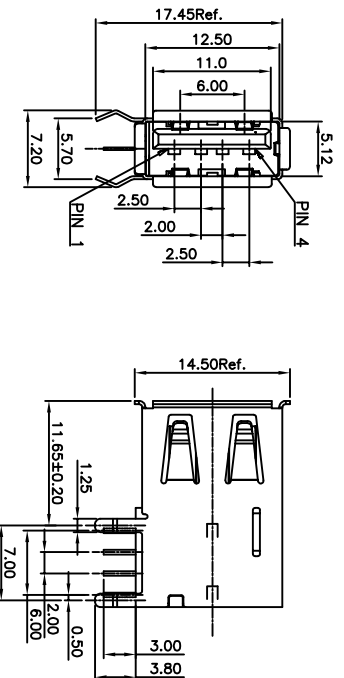
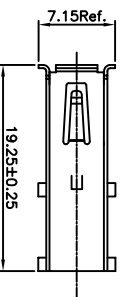

No.of CKTS	Part No.
04	0600035-041002

Specifications

Rating

Current Rating:1.5 Amp Max.
Voltage Rating:150V AC/DC Max.
Operating Temperature Range:-25°~+85°C

Electrical

Contact resistance:30m Ohm Max
Insulator resistance:1000M ohm min.
Withstanding Voltage:500V AC/Minute

Material And Finish

Insulator:PBT UL94V-0 Color:Black
Contact:Copper Alloy
Plated:Gold Flash; Soldertail:Tin.
Shell:Copper Alloy With Nickel Plate

**Universal Serial Bus (USB)
I/O Connectors
Type 'A' Female**

0600052

Right Angle, Through Hole

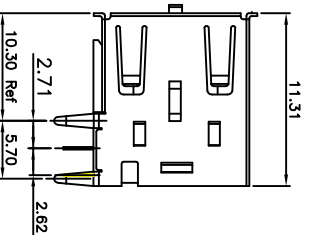
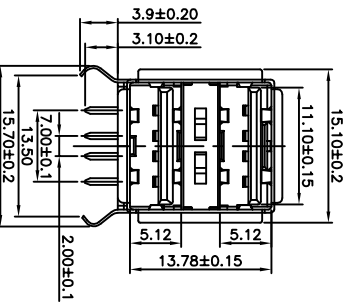
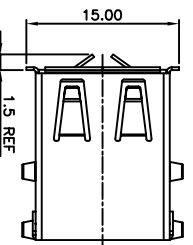

No.of CKTS	Part No.
08	0600052-081002

Specifications

Rating

Current Rating:1.5 Amp Max.
Voltage Rating:150V AC/DC Max.
Operating Temperature Range:-25°~+85°C

Electrical

Contact resistance:30m Ohm Max
Insulator resistance:1000M ohm min.
Withstanding Voltage:500V AC/Minute

Material And Finish

Insulator:PBT UL94V-0 Color:Black
Contact:Copper Alloy
Plated:Gold Flash; Soldertail:Tin.
Shell:Copper Alloy With Nickel Plate

**Universal Serial Bus (USB)
I/O Connectors
Type 'B' Female**

0600042

Right Angle, Through Hole

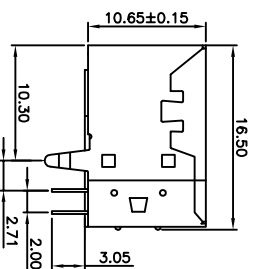
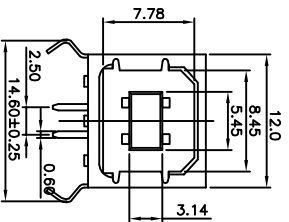

- Specifications**
- Rating**
 Current Rating:1.5 Amp Max.
 Voltage Rating:150V AC/DC Max.
 Operating Temperature Range:-25~+85°C
- Electrical**
 Contact resistance:30m Ohm Max
 Insulator resistance:1000M ohm min.
 Withstanding Voltage:500V AC/Minute
- Material And Finish**
 Insulator:PBT UL94V-0 Color:Black
 Contact:Copper Alloy
 Plated:Gold Flash; Soldertail:Tin.
 Shell:Copper Alloy With Nickel Plate

No.of CKTS	Part No.
04	0600042-041002

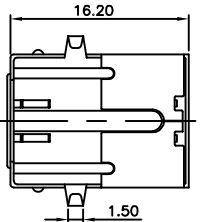

**Universal Serial Bus (USB)
I/O Connectors
Type 'B' Female**

0600041

Vertical, Through Hole

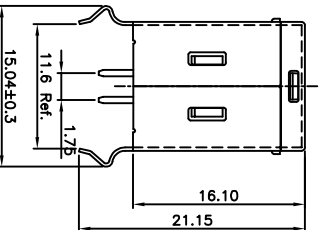
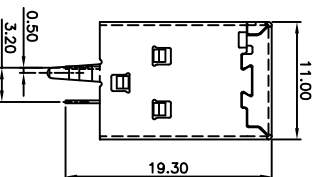
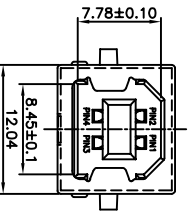

- Specifications**
- Rating**
 Current Rating:1.5 Amp Max.
 Voltage Rating:150V AC/DC Max.
 Operating Temperature Range:-25~+85°C
- Electrical**
 Contact resistance:30m Ohm Max
 Insulator resistance:1000M ohm min.
 Withstanding Voltage:500V AC/Minute
- Material And Finish**
 Insulator:Nylon 6T UL94V-0 Color:Black
 Contact:Copper Alloy
 Plated:Gold Flash; Soldertail:Tin.
 Shell:Copper Alloy With Nickel Plate

No.of CKTS	Part No.
04	0600041-041002

Universal Serial Bus (USB)

I/O Connectors

Mini-B Female

0600063

Right Angle, SMT

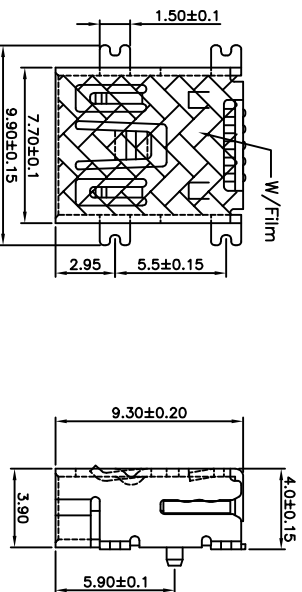

- Specifications**
- Rating**
- Current Rating:1.0 Amp Max.
- Voltage Rating:30V AC/DC Max.
- Operating Temperature Range:-25~+85°C
- Electrical**
- Contact resistance:50m Ohm Max
- Insulator resistance:100M ohm min.
- Withstanding Voltage:100V AC/Minute
- Material And Finish**
- Insulator:LCP UL94V-0 Color:Black
- Contact:Copper Alloy
- Plated:Gold Flash; Soldertail:TiN.
- Shell:Copper Alloy With Nickel Plate

No.of CKTS	Part No.
05	0600063-051301

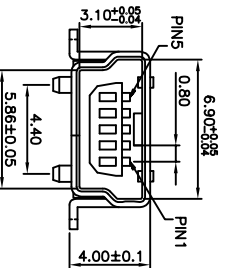

Universal Serial Bus (USB)

I/O Connectors

Mini-B Female

0600072

Right Angle, Through Hole

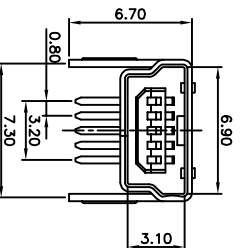
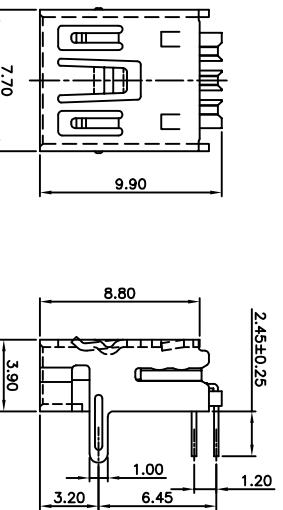

- Specifications**
- Rating**
- Current Rating:1.0 Amp Max.
- Voltage Rating:30V AC/DC Max.
- Operating Temperature Range:-25~+85°C
- Electrical**
- Contact resistance:50m Ohm Max
- Insulator resistance:100M ohm min.
- Withstanding Voltage:100V AC/Minute
- Material And Finish**
- Insulator:LCP UL94V-0 Color:Black
- Contact:Copper Alloy
- Plated:Gold Flash; Soldertail:TiN.
- Shell:Copper Alloy With Nickel Plate

No.of CKTS	Part No.
05	0600072-051302

Universal Serial Bus (USB)

I/O Connectors

Mini-B Female

0600163

Right Angle, SMT

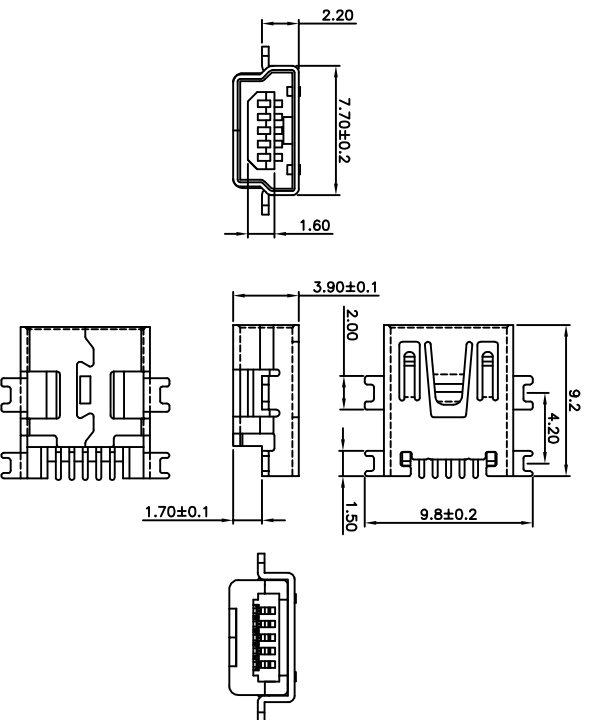

Specifications

Rating

Current Rating:1.0 Amp Max.
Voltage Rating:30V AC/DC Max.
Operating Temperature Range:-25~+85°C

Electrical

Contact resistance:50m Ohm Max
Insulator resistance:1000M ohm min.
Withstanding Voltage:100V AC/Minute

Material And Finish

Insulator:LCP UL94V-0 Color:Black
Contact:Copper Alloy
Plated:Gold Flash; Soldertail:Ti.
Shell:Copper Alloy With Nickel Plate

No.of CKTS	Part No.
05	600163-051301

Universal Serial Bus (USB)

I/O Connectors

Micro-USB B Female

0600083

Right Angle, SMT

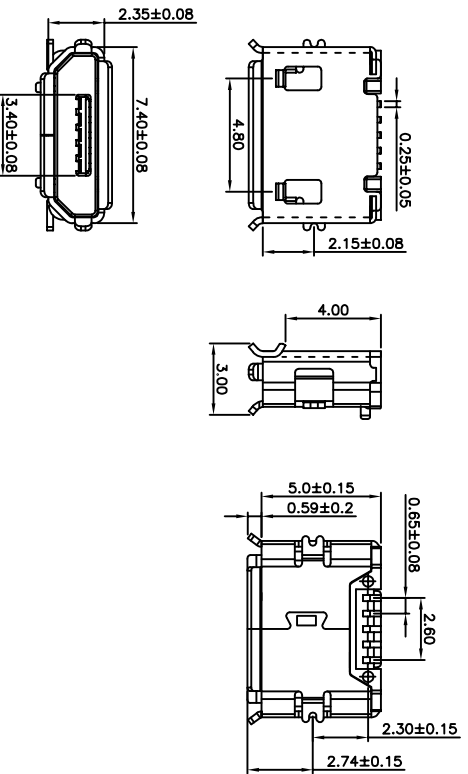

Specifications

Rating

Current Rating:1.0 Amp Max.
Voltage Rating:30V AC/DC Max.
Operating Temperature Range:-25~+85°C

Electrical

Contact resistance:30m Ohm Max
Insulator resistance:1000M ohm min.
Withstanding Voltage:500V AC/Minute

Material And Finish

Insulator:LCP UL94V-0 Color:Black
Contact:Copper Alloy
Plated:Gold Flash; Soldertail:Ti.
Shell:Copper Alloy With Nickel Plate

No.of CKTS	Part No.
05	0600083-051307

**Universal Serial Bus (USB)
I/O Connectors
Micro-USB B Female**

0600085

Right Angle, SMT

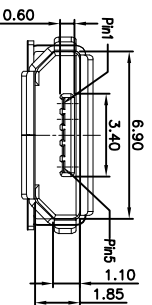
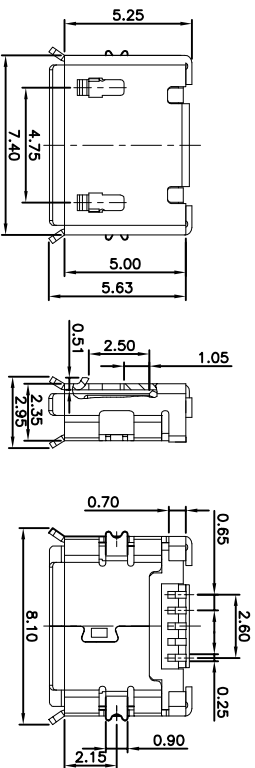

No. of CKTS	Part No.
05	0600085-051307

**Universal Serial Bus (USB)
I/O Connectors
Micro-USB B Female**

0600103

Right Angle, SMT

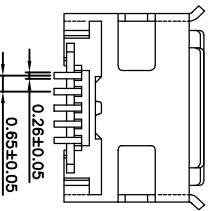
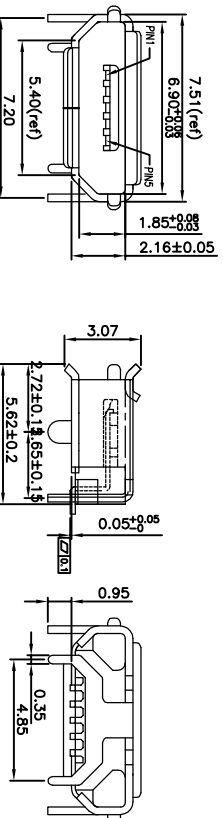

No. of CKTS	Part No.
05	0600103-051307

Specifications

Rating

Current Rating:1.0 Amp Max.
Voltage Rating:30V AC/DC Max.
Operating Temperature Range:--25~+85°C

Electrical

Contact resistance:30m Ohm Max
Insulator resistance:1000M ohm min.
Withstanding Voltage:500V AC/Minute

Material And Finish

Insulator:LCP UL94V-0 Color:Black
Contact:Copper Alloy
Plated:Gold Flash; Solder tail:Tin.
Shell:Copper Alloy With Nickel Plate

**Universal Serial Bus (USB)
I/O Connectors
Micro-USB B Female**

0600096

Right Angle, SMT

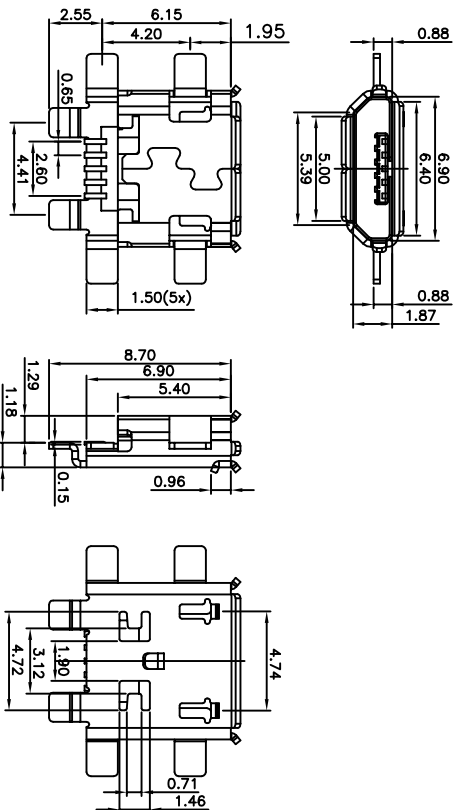

No. of CKTS	Part No.
05	0600096-051307

Specifications

Rating

Current Rating:1.0 Amp Max.
Voltage Rating:30V AC/DC Max.
Operating Temperature Range:-25~+85°C

Electrical

Contact resistance:30m Ohm Max
Insulator resistance:1000M ohm min.
Withstanding Voltage:500V AC/Minute

Material And Finish

Insulator:LCP UL94V-0 Color:Black
Contact:Copper Alloy
Plated:Gold Flash; Solder tail:Tin.
Shell:Copper Alloy With Nickel Plate

**Universal Serial Bus (USB)
I/O Connectors
USB3.0 'A' Female**

0600114

Right Angle, Through Hole

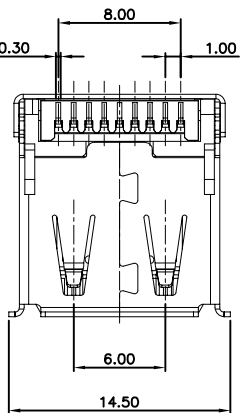
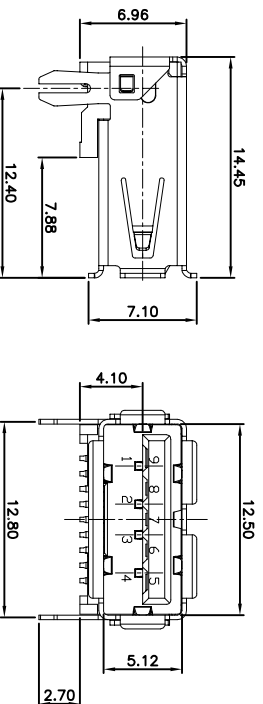
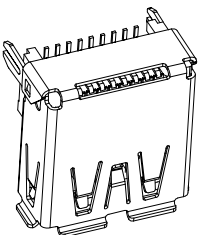

Specifications

Rating

Current Rating:1.8 Amps MAX. for Pin1&Pin4
0.25 Amps MIN. for all other contact.
Voltage Rating:30V AC/DC
Operating Temperature Range:-25~+85°C

Electrical

Contact resistance:30m Ohm Max
Insulator resistance:1000M ohm min.
Withstanding Voltage:500V AC/Minute

Material And Finish

Insulator:LCP UL94V-0 Color:Blue
Contact:Copper Alloy
Plated:Gold Flash; Solder tail:Tin.
Shell:Copper Alloy With Nickel Plate

No. of CKTS	Part No.
09	0600114-091352

**Universal Serial Bus (USB)
I/O Connectors
USB3.0 'A' Female**

0600112

Right Angle, Through Hole

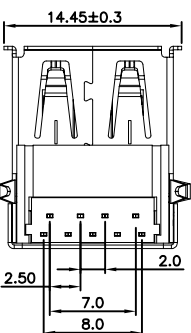
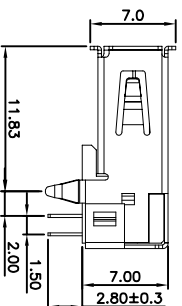
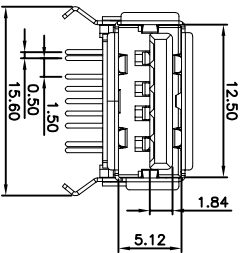

No.of CKTS	Part No.
09	0600112-091052

**Universal Serial Bus (USB)
I/O Connectors
Micro-USB 3.0 B Female**

0600134

Right Angle, SMT

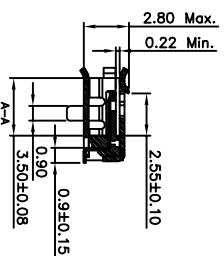
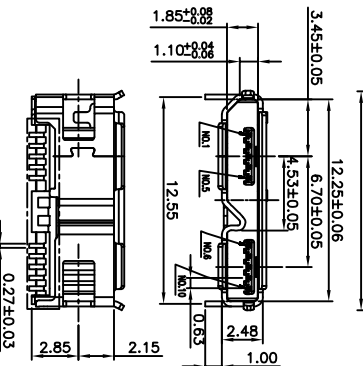
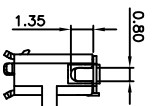
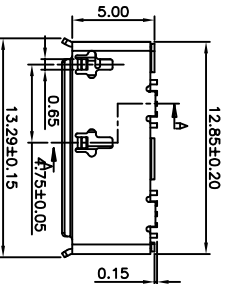

No.of CKTS	Part No.
10	0600134-101307

Specifications

Rating

Current Rating:1.8 Amps MAX. for Pin1&Pin4
0.25 Amps MIN. for all other contact.
Voltage Rating:30V AC/DC
Operating Temperature Range:--25~+85°C

Electrical

Contact resistance:30m Ohm Max
Insulator resistance:1000M ohm min.
Withstanding Voltage:500V AC/Minute

Material And Finish

Insulator:PBT UL94V-0 Color:Blue
Contact:Copper Alloy
Plated:Gold Flash; Soldertail:Tim.
Shell:Copper Alloy With Nickel Plate

Specifications

Rating

Current Rating:1.0 Amps
Voltage Rating:30V AC/DC
Operating Temperature Range:--25~+85°C

Electrical

Contact resistance:30m Ohm Max
Insulator resistance:1000M ohm min.
Withstanding Voltage:500V AC/Minute

Material And Finish

Insulator:LCP UL94V-0 Color:Black
Contact:Copper Alloy
Plated:Gold Flash; Soldertail:Tim.
Shell:Copper Alloy With Nickel Plate

Universal Serial Bus (USB)

I/O Connectors

USB3.0 'A' Female

0600141

Vertical, Through Hole

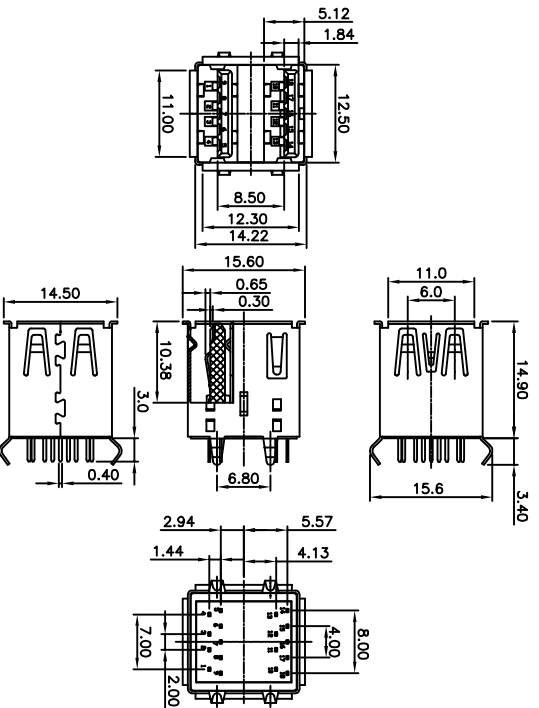

Specifications
Rating
 Current Rating:1.8 Amps MAX. for Pin1&Pin4 (for VBUS and GND contacts)
 0.25 Amps MIN. for all other contact.
 Voltage Rating:30V AC/DC
 Operating Temperature Range:-25~+85°C

Electrical
 Contact resistance:30m Ohm Max
 Insulator resistance:1000M ohm min.
 Withstanding Voltage:500V AC/Minute

Material And Finish
 Insulator:PBT UL94V-0 Color:Blue
 Contact:Copper Alloy
 Plated:Gold Flash; Soldertail:Fin.
 Shell:Copper Alloy With Nickel Plate

No.of CKTS	Part No.
18	0600141-181052

Universal Serial Bus (USB)

I/O Connectors

USB3.0 'A' Female

0600142

Right Angle, Through Hole

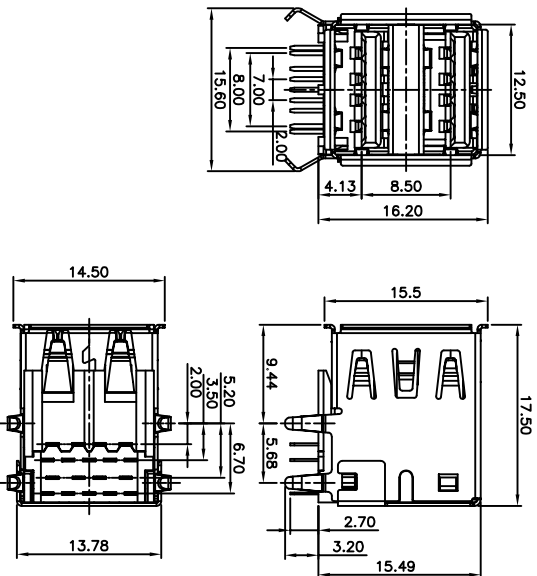
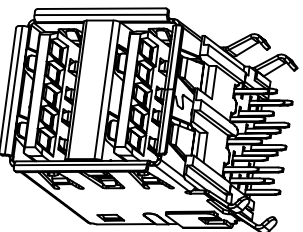

Specifications
Rating
 Current Rating:1.8 Amps MAX. for Pin1&Pin4 (for VBUS and GND contacts)
 0.25 Amps MIN. for all other contact.
 Voltage Rating:30V AC/DC
 Operating Temperature Range:-25~+85°C

Electrical
 Contact resistance:30m Ohm Max
 Insulator resistance:1000M ohm min.
 Withstanding Voltage:500V AC/Minute

Material And Finish
 Insulator:PBT UL94V-0 Color:Blue
 Contact:Copper Alloy
 Plated:Gold Flash; Soldertail:Fin.
 Shell:Copper Alloy With Nickel Plate

No.of CKTS	Part No.
18	0600142-181052

Universal Serial Bus (USB)

I/O Connectors

USB3.1 'C' Female

0600154

Right Angle, SMT

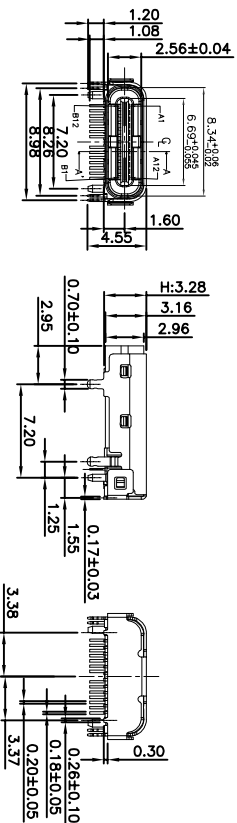
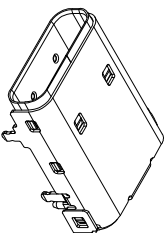

- Specifications**
- Rating**
- Current Rating: 5.0 Amps MAX. for Pin(A4,A9,B4,B9) 1.25 Amps MIN. for all other contact.
 - Voltage Rating:100V AC/DC
 - Operating Temperature Range: -25~+85°C
- Electrical**
- Contact resistance:50m Ohm Max
 - Insulator resistance:100M ohm min.
 - Withstanding Voltage:500V AC/Minute
- Mechanical Characteristic**
- Insertion Force:5-20N
 - Extraction Force:8-20N
 - Durability:10000 Cycles

Material And Finish

Insulator:LCP UL94V-0 Color:Black
 Contact:Copper Alloy
 Plated:Gold 15u" ; Solder tail: Tin.
 Shell:Stainless Steel With Nickel Plated

No.of CKTS	Part No.
18	0600154-CF8303

Universal Serial Bus (USB)

I/O Connectors

USB3.0 'B' Female

0600122

Right Angle, Through Hole

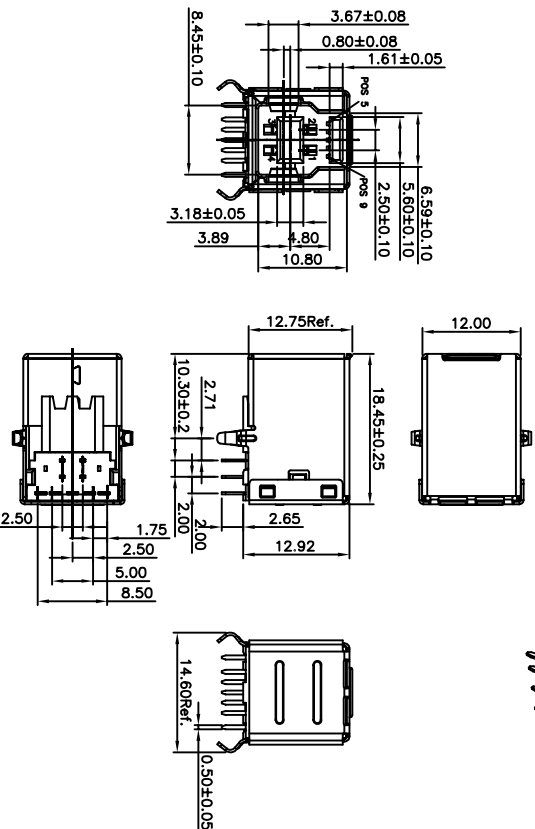
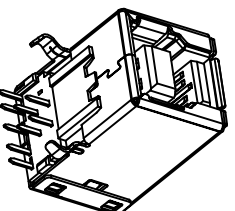

- Specifications**
- Rating**
- Current Rating:1.8 Amps MAX. for Pin1&Pin4 0.25 Amps MIN. for all other contact.
 - Voltage Rating:30V AC/DC
 - Operating Temperature Range:-25~+85°C

Electrical

Contact resistance:30m Ohm Max
 Insulator resistance:1000M ohm min.
 Withstanding Voltage:500V AC/Minute

Material And Finish

Insulator:PBT UL94V-0 Color:Blue
 Contact:Copper Alloy
 Plated:Gold Flash; Solder tail: Tin.
 Shell:Copper Alloy With Nickel Plate

No.of CKTS	Part No.
09	0600122-091052